

Mediblink[®]
medical devices



EN Mediblink Ultrasonic nebulizer M480

INSTRUCTIONS FOR USE

Please read this guidebook completely before operating this unit.

SLO Mediblink Ultrazvočni inhalator M480

NAVODILA ZA UPORABO

Prosimo, da pred uporabo izdelka v celoti preberete navodila za uporabo

HRV Mediblink Ultrazvučni inhalator M480

UPUTE ZA UPOTREBU

Pažljivo pročitajte upute prije upotrebe uređaja

Introduction	5
Accessories	6
Device Components	7
Warnings	8
Aerosol output of NaF	9
Symbol use	13
Instructions	14
Cleaning and maintenance	17
Filter change	17
Technical features	18
Troubleshooting	18
EMC Declaration	19
Warranty	23

Uvod	25
Dodatki	26
Sestavni deli inhalatorja	27
Opozorila	28
Izhod razpršila NaF	29
Uporabljeni simboli	33
Navodila	34
Čiščenje in vzdrževanje	37
Menjava filtra	37
Tehnične lastnosti	38
Odpravljanje težav	38
Izjava o elektromagnetni združljivosti	39
Garancija	43

Uvod	45
Pribor	46
Dijelovi uređaja	47
Upozorenja	48
Izlaz aerosola NaF	49
Upotreba simbola	53
Upute	54
Čišćenje i održavanje	57
Zamjena filtra	57
Tehnička svojstva	58
Rješavanje problema	59
Izjava o elektromagnetskoj kompatibilnosti (EMC)	59
Jamstvo	63

Introduction

Dear Customer,

Thank you for choosing Mediblink Ultrasonic Nebulizer M480, an ultrasonic aerosol therapy unit designed and manufactured according to the most up-to-date technologies.

Mediblink Ultrasonic Nebulizer M480 is a class IIa medical device which converts medicines from liquid or suspension form to aerosol form, so they can be administered directly to the airways.

Mediblink Ultrasonic Nebulizer M480 allows for deeper penetration of the medicine in the respiratory tract, ensured by the perfect size of the aerosol particles.

Warning!

This product must be assembled, maintained and handled by an adult. Never leave children alone during use: the unit contains small parts that could be swallowed. This product must remain in place for use only for the time strictly needed. Once treatment has been completed, the unit must be stored in a safe place out of reach of children. Before using the appliance, we highly recommend that you read the short list of warnings contained in this manual, to make sure you have correctly understood how to use it.

Accessories

The device includes the following parts, provided in a polyethylene envelope supplied with the device.

List of Accessories

No.	Component	Model no.	Item no.	Material	Quantity
1	Adult mask	PNEMAD	180-S08MZ7	PVC+PP	1
2	Pediatric mask	PNEMIN	180-S09MZ8	PVC+PP	1
3	Medicine cup	PNEBCAM3	XC-S02YB	PVC	10
4	Sealed ring	PNEBUANL	180-G02DQ	Silicon	3
5	Extension tube	PNEBTUB3	180-S06SSG1	PP	1
6	Adapter	RSS1006-180240-W2B-H	180-D02SPQ	/	1
7	Mouthpiece	PNEMOU	180-S01YZ	PP	1
8	Nosepiece	PNEBNOS	180-S08BC7	PP	1

Picture 1: Nebulizer Accessories

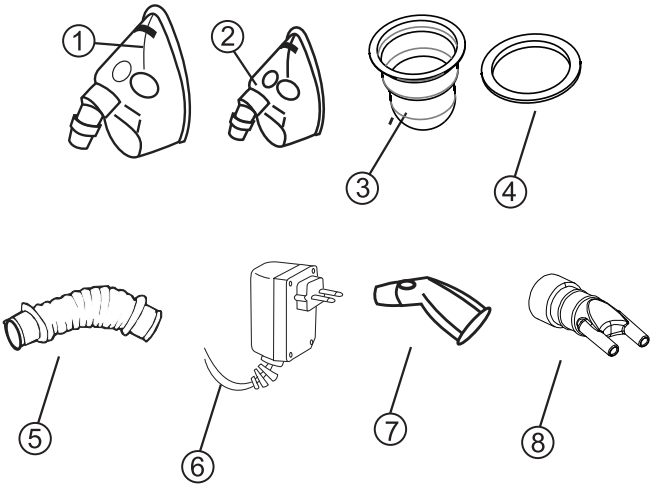

Device Components

Your ultrasound Mediblink M480 system for aerosol therapy.

Picture 2: Nebulizer Components

- 1 – Atomizing nozzle (or Blue Connector)
- 2 – Medicine Cup
- 3 – Sealed ring
- 4 – Sensor for water level
- 5 – Body of the device with water tank
- 6 – Switch
- 7 – Warning light

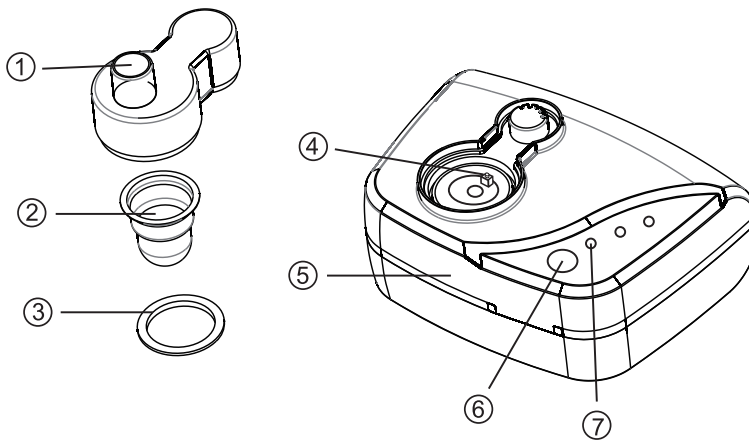

Introduction

Intended use: The Ultrasonic Nebulizer for Conscious Patients is intended for converting Albuterol Sulfate or saline solution fluid into an aerosol for inhalation by adult or pediatric patients.

Contraindication: Never use with unconscious patients.

Target user group: Legally certified medical experts, such as doctors, nurses and therapists or healthcare personnel or patients under the guidance of qualified medical experts for home treatment.

The medical conditions to be treated: The device is intended for use in the treatment of asthma, COPD and other respiratory ailments in which an aerosolized medication or saline solution is required during therapy.

The lifespan of the device is 5 years.

Warnings and precautions, operating cautions

1. Keep your eyes away from the output of medication mist. Change the water after each use.
2. The maximum capacity of the medication cup is 10ml and it should not be overfilled.
3. Dilute dense medications or medication volumes 2ml or less with distilled water or saline solution to obtain a volume of at least 4ml.
4. Do not use this unit while operating a vehicle.
5. If any discomfort or abnormality occurs, stop using the unit immediately.

Warnings

1. Do not expose the Nebulizer to: high temperatures, humidity, dust or direct light.
2. Do not drop it or shock it.
3. To avoid infections and contagions, the mask, medicine cup and extension tube must be treated as disposable.
4. Do not fill the tank above the volume specified in the manual.
5. Do not let the medicine remain in the nebulization chamber if the Nebulizer is not in use.
6. Disconnect the Nebulizer from the electric outlet before cleaning, filling with medicine and after each use.
7. Use the Nebulizer on an intermittent basis, i.e., after 20 minutes, discontinue use for 40 minutes and, if necessary, return it to use for no longer than 20 minutes.
8. Never wash, soak or submerge the nebulizer in water or any other liquid. To clean it, follow the precise instructions in the item MAINTENANCE AND CLEANING in this manual.
9. Do not use it with wet hands, as there is a risk of damaging the nebulizer and the user.
10. Never use the unit if it has damaged parts (including the power cord), or if it has been dropped or submerged in water. Send it immediately to technical assistance for tests and repairs.
11. Children must not use the Nebulizer without an adult's supervision.
12. Do not deflect the nebulizer as there is a risk of medicine leakage and malfunction.
13. Please use the adult mask, a pediatric mask with a CE certificate with notified body number.
14. The accessories are disposable products that can't be reused. If you need to replace them with new accessories, please contact local Mediblink distributor.
15. For hygiene reasons, each user must use their own accessories and accessories for single-use.

Aerosol output of NaF

1. Test method

- a) Air is used.
- b) The nebulizer is filled with the tested drug (2ml NaF 1.0% (M/V) and the flow rates are 2 L/min) for the aerosol output rate and aerosol output test.
- c) The aerosol output is expressed as millilitres of NaF 1.0% (M/V).
- d) The nebulizer is filled with the tested drug (2ml NaF 2.5% (M/V) and the flow rates are 2 L/min) for the particle sizing test.

Aerosol output of NaF

2. NaF (minimum speed) test results

Table 1: Summary of the test results for the proposed device (M480)

Test	Features	
Particle sizing	Total output particle mass (M ₁ , µg)	26273.36 ± 3410.11
	Particle mass collected by the cascade impactor (M ₁ , µg)	354.63 ± 15.38
	Particle mass collected by the outlet filter (M ₁ , µg)	2228.35 ± 108.35
	MMAD (µm)	1.52 ± 0.1
	C.V. for the MMAD between four tests (%)	6.38
	Geometric Std. Dev. (GSD)	1.65 ± 0.16
	C.V. for the GSD between four tests (%)	9.89
	Respirable fraction (% 0.5-5 µm)	93.49 ± 0.9
	Respirable Mass (µg 0.5-5 µm)	331.61 ± 17
	Treatment time (min)	1
	Course particle Fraction (%) (> 4.7 µm)	6.89 ± 1.22
	Fine particle Fraction (%) (< 4.7 µm)	93.11 ± 1.22
	Ultra-fine particle Fraction (%) (< 1 µm)	13.33 ± 4.56
Aerosol output and aerosol output rate	Aerosol output (ml) ^a	2.06 ± 0.13
	Aerosol output rate (ml/min) ^b	0.6 ± 0.04

a : Continue the treatment until the medicine cup is empty or the mist stops.
 b : The treatment time for aerosol output rate is 1 min.

Table 2: Mass fraction of the drug collected on each stage of the Marple impactor

stage No.	Effective cutoff dia. (µm)	Cumulative fraction (%)					Mean collected mass per minute for each stage (µg/min)	Mean mass fraction for each stage (%)
		Test 1	Test 2	Test 3	Test 4	Mean		
1	21.3	100.00	100.00	100.00	100.00	100.00	9.40	2.65
2	14.8	97.30	97.27	97.41	97.41	97.35	9.55	2.69
3	9.8	94.13	94.87	94.93	94.66	94.65	10.90	3.07
4	6	91.07	91.64	92.00	91.58	91.57	33.85	9.55
5	3.5	79.45	83.50	83.05	81.98	82.00	85.10	24.00
6	1.6	52.85	60.81	59.54	58.59	57.95	186.20	52.51
7	0.93	11.92	0.00	6.73	3.99	5.66	19.28	5.44
8	0.53	0.30	0.00	0.11	0.00	0.10	0.35	0.10
after filter	<0.53	0.00	0.00	0.00	0.00	0.00	0.00	0.00
Total							354.63	

Figure A: Plot of the cumulative size distribution of the results in table 2

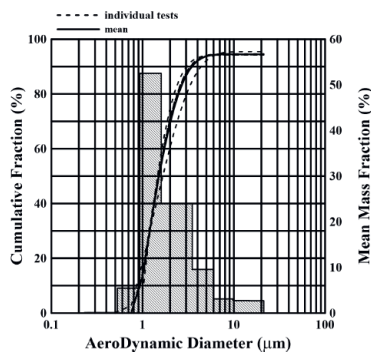

Reference

Rubow, K. L., Marple, V. A., Olin, J., and McCawley, M. A., 1987, "A Personal Cascade Impactor: Design, Evaluation and Calibration", *Am. Ind. Hyg. Assoc. J.* (48): 532-538.

Aerosol output of NaF

3. NaF (medium speed) test results

Table 3: Summary of the test results for the proposed device (M480)

Test	Features	
Particle sizing	Total output particle mass (M_1 , μg)	32055.23 \pm 1531.12
	Particle mass collected by the cascade impactor (M_2 , μg)	304.15 \pm 10.46
	Particle mass collected by the outlet filter (M_3 , μg)	1436.3 \pm 515.7
	MMAD (μm)	1.39 \pm 0.06
	C.V. for the MMAD between four tests (%)	4.52
	Geometric Std. Dev. (GSD)	1.73 \pm 0.05
	C.V. for the GSD between four tests (%)	2.84
	Respirable fraction (% 0.5-5 μm)	95.92 \pm 1.04
	Respirable Mass (μg 0.5-5 μm)	291.67 \pm 7.54
	Treatment time (min)	1
	Coarse particle Fraction (%) ($>$ 4.7 μm)	4.48 \pm 1.14
	Fine particle Fraction (%) ($<$ 4.7 μm)	95.52 \pm 1.14
	Ultra-fine particle Fraction (%) ($<$ 1 μm)	26.06 \pm 2.12
Aerosol output and aerosol output rate	Aerosol output (ml) ^a	2.16 \pm 0.21
	Aerosol output rate (ml/min) ^b	0.67 \pm 0.07

a : Continue the treatment until the medicine cup is empty or the mist stops.

b : The treatment time for aerosol output rate is 1 min.

Table 4: Mass fraction of the drug collected on each stage of the Marple impactor

stage No.	Effective cutoff dia. (μm)	Cumulative fraction (%)					Mean collected mass per minute for each stage ($\mu\text{g}/\text{min}$)	Mean mass fraction for each stage (%)
		Test 1	Test 2	Test 3	Test 4	Mean		
1	21.3	100.00	100.00	100.00	100.00	100.00	4.00	1.32
2	14.8	98.27	99.12	98.60	98.78	98.69	3.05	1.00
3	9.8	96.80	98.71	97.45	97.83	97.70	9.80	3.22
4	6	93.09	96.00	94.20	94.65	94.48	23.35	7.68
5	3.5	83.31	90.09	85.97	88.02	86.85	75.33	24.77
6	1.6	59.27	64.52	61.93	62.53	62.06	129.20	42.48
7	0.93	16.69	22.18	20.06	19.36	19.57	59.07	19.42
8	0.53	0.32	0.00	0.13	0.00	0.11	0.35	0.12
after filter	<0.53	0.00	0.00	0.00	0.00	0.00	0.00	0.00
Total							304.15	

Figure B: Plot of the cumulative size distribution of the results in table 4

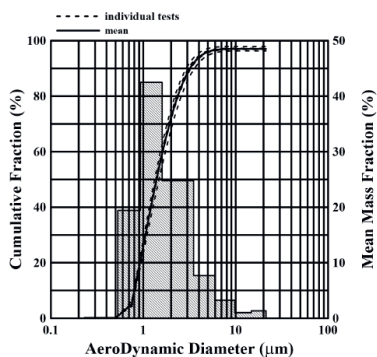

Reference

Rubow, K. L., Marple, V. A., Olin, J., and Mccawley, M. A., 1987, "A Personal Cascade Impactor: Design, Evaluation and Calibration", *Am. Ind. Hyg. Assoc. J.* (48): 532-538.

Aerosol output of NaF

4. NaF (maximum speed) test results

Table 5: Summary of the test results for the proposed device (M480)

Test	Features	
Particle sizing	Total output particle mass (M_1 , μg)	23967.07 \pm 1633.28
	Particle mass collected by the cascade impactor (M_2 , μg)	256.75 \pm 136.63
	Particle mass collected by the outlet filter (M_3 , μg)	1488 \pm 426.33
	MMAD (μm)	1.19 \pm 0.18
	C.V. for the MMAD between four tests (%)	15.27
	Geometric Std. Dev. (GSD)	1.72 \pm 0.28
	C.V. for the GSD between four tests (%)	16.04
	Respirable fraction (% 0.5-5 μm)	96.43 \pm 2.09
	Respirable Mass (μg 0.5-5 μm)	245.52 \pm 128.01
	Treatment time (min)	1
	Coarse particle Fraction (%) (> 4.7 μm)	3.85 \pm 2.3
	Fine particle Fraction (%) (< 4.7 μm)	96.15 \pm 2.3
	Ultra-fine particle Fraction (%) (< 1 μm)	41.04 \pm 13.1
Aerosol output and aerosol output rate	Aerosol output (ml) ^a	2.15 \pm 0.04
	Aerosol output rate (ml/min) ^b	0.66 \pm 0.01

a : Continue the treatment until the medicine cup is empty or the mist stops.

b : The treatment time for aerosol output rate is 1 min.

Table 6: Mass fraction of the drug collected on each stage of the Marple impactor

stage No.	Effective cutoff dia. (μm)	Cumulative fraction (%)					Mean collected mass per minute for each stage ($\mu\text{g}/\text{min}$)	Mean mass fraction for each stage (%)
		Test 1	Test 2	Test 3	Test 4	Mean		
1	21.3	100.00	100.00	100.00	100.00	100.00	5.05	1.97
2	14.8	100.00	97.66	98.32	97.80	98.45	3.25	1.27
3	9.8	100.00	96.14	97.17	96.45	97.44	5.90	2.30
4	6	100.00	93.40	95.31	93.83	95.63	18.00	7.01
5	3.5	97.25	85.89	88.04	86.55	89.43	51.45	20.04
6	1.6	94.50	63.91	68.73	64.12	72.82	94.30	36.73
7	0.93	50.50	28.83	30.12	28.48	34.48	78.25	30.48
8	0.53	1.50	0.00	0.09	0.24	0.46	0.55	0.21
after filter	-0.53	0.00	0.00	0.00	0.00	0.00	0.00	0.00
Total							256.75	



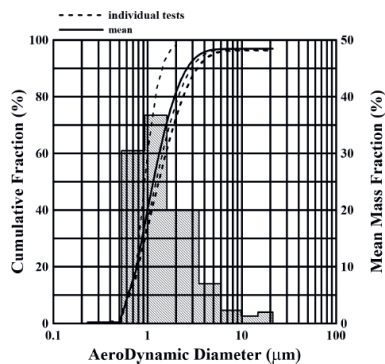







Figure C: Plot of the cumulative size distribution of the results in table 6













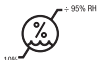
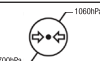

Reference

Rubow, K. L., Marple, V. A., Olin, J., and Mccawley, M. A., 1987, "A Personal Cascade Impactor: Design, Evaluation and Calibration", *Am. Ind. Hyg. Assoc. J.* (48): 532-538.

Symbol use

Symbols	Meanings of Symbols
	Type BF Applied Part
	Class II equipment
	Refer to instruction manual/ booklet e-IFU: http://www.mediblink.com/ff/m480.pdf
	Manufacturer
	Date of manufacture
	Authorized Representative in the European community
	Medical Device
	Batch code*
	Serial number
	Use-by date
	The marking of electrical and electronic devices is according to Directive 2002/96/EC. The device, accessories and packaging must be disposed of correctly after usage. Please follow the Local Ordinances or Regulations for disposal.

Symbols	Meanings of Symbols
	Non-sterile
	Do not re-use
	CE marking
	Protected against solid foreign objects of 12.5mm diameter and greater.
	Number of products in one packaging
	Storage temperature limit
	Storage humidity limitation
	Storage atmospheric pressure limitation
	This way up
	Fragile, handle with care
	Keep dry
	Stacking limit of 6
	Caution!

*Date of manufacture: the first pair of LOT numbers presents month of manufacture, the second pair of numbers presents the year of production. Example: LOT 1025 = October 2025.

Follow the precise use instructions contained in this manual and do not use the Nebulizer in any way not described in this manual (such as using accessories not provided by the manufacturer, inserting objects or opening it) at risk of accidents and loss of warranty.



ATTENTION – Instructions for the correct disposal of the product

This symbol indicates that the product must not be disposed of with domestic waste after use, but in accordance with the legal provisions in force, in order to avoid negative health and environmental implications.

Storage Cautions

Do not store the unit in direct sunlight, high temperature or humidity.
Keep the unit out of reach of small children.
Always keep the unit unplugged while not in use.

Instructions

1. Consult your family doctor before using this device.
2. Keep the device out of children's reach.
3. Once the treatment is over, disconnect the device from the socket by unplugging the adapter.

For the correct use and maintenance time of your new system for aerosol therapy, we recommend reading the following indications carefully.

How to use your M480 nebulizer for aerosol therapy

Make sure that the device and all the accessories are thoroughly clean, then proceed consecutively with the following operations:

1. Position the device on a stable, bare flat surface (table without a tablecloth or other covering) near a power point.
2. Open the device cover.
3. Remove the upper part as shown in Fig.1.
4. Fill the tank with cold tap-water (distilled water or filtered water are not allowed, using a small container as shown in Fig.2, to the level indicated inside the tank (Fig.9); this water allows the conduction of ultrasound waves to the medicine and is never nebulized.
5. Take a medicine cup with the medicine in it as shown in Fig.3.
6. Put the sealed ring on the machine around the mouth of the tank before placing the medicine cup in.
7. Place the medicine cup with the medicine in its slot under the upper part of the device (Fig.4), without spilling the drug from the medicine cup.
8. Place the upper part onto the body of the device by carefully joining the two parts.
9. Match the connector with the extension tube, then connect the free end of the connector to the mask for nebulized drug emission (Fig.5), and apply the free end of the extension tube to either of the two masks, the mouthpiece or the nasal piece, according to the treatment required and to the mode of administration selected.
10. Insert the current adapter into the socket on the back of the device.
11.  Warning! The air outlet is strictly prohibited from entering water. Please see Fig.8.
12. Note the line for the water level in the water tank (see Fig.9); the water tank must be used with tap-water, distilled water or filtered water are not permitted because the sensor cannot work with them.

Now the device is ready for use.

Instructions

How to perform aerosol therapy

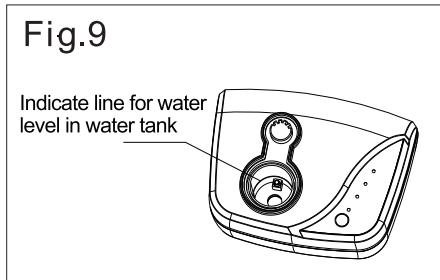
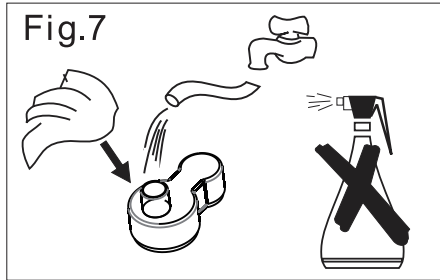
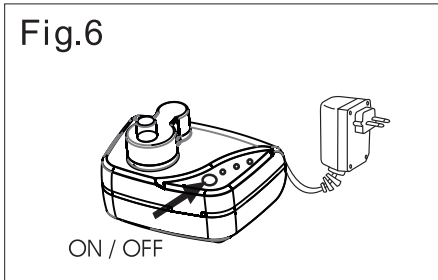
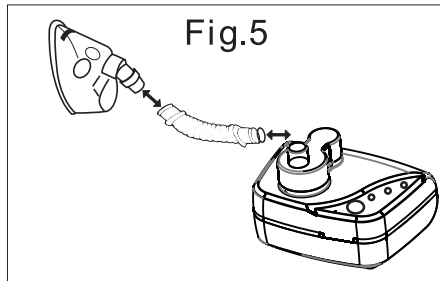
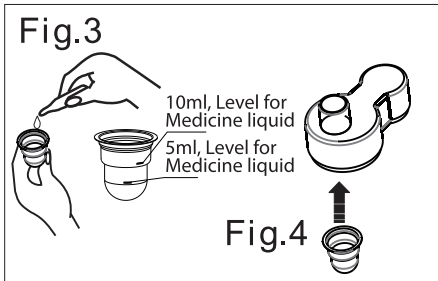
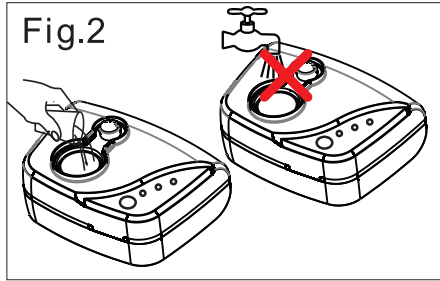
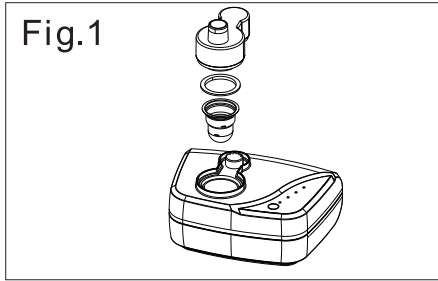

Instructions

1. Plug the current adapter into a suitable socket (see the label on the bottom of the device).
2. Press the switch on the top of the device: the warning light on the top lights up (green light) indicating that the device is working.
3. During therapy, keep the device in a vertical position to allow the correct functioning of the device, and to achieve the greatest effectiveness.
4. The drug nebulization speed may be controlled by pressing 'MIN', 'MID' and 'MAX'. During child treatment, we mostly advise turning the knob to the 'MIN' position, in order to help airway deposition.
5. Continue the treatment until a light mist is visible (drug nebulization generated by the device).
6. After one treatment session, it is necessary to refill the water in the tank for the next treatment.

⚠ Caution: normally, at the end of the treatment, a small amount of medicine remains in the Medicine holder: this amount, called the residual volume, cannot be nebulized.

Once the treatment is over:

1. Switch the device off by pressing the switch control.
2. Disconnect the current adapter from the power point.
3. Remove the current adapter from the socket on the back of the device.
4. Remove the blue connector from the nebulizer body, and the mask (or other accessory) from the end of the extension tube.
5. Remove the blue connector from the extension tube.
6. Remove the medicine cup and sealed ring from the body of the device.
7. Remove the water from the water tank.
8. Wipe the water tank carefully with a soft cloth, and make sure that the water tank and blue connector are completely dry.
9. Place the medicine cup, sealed ring and blue connector onto the body of the device.
10. Place all the accessories into the box, together with the device.

Cleaning and maintenance

Cautions:

Check the medication cup and air filter before each use. Dirty or worn parts should be replaced. Do not immerse the unit in water.

It is important to clean your Ultrasonic Nebulizer before it is used for the first time and after each use. Remember to disconnect the unit from the electrical outlet. Never immerse the unit in water. It may damage the unit.

Do not use any powdered cleaners or soap pads, which may damage the finish.

Cleaning the device

1. Disconnect the unit from the electrical outlet before cleaning.
2. The surface of the main unit should be cleaned with a soft cloth moistened with a non-abrasive cleanser and water below 30°C. Don't put the main unit directly into water. The ultrasonic part can be wiped with a cotton stick with clean water below 30°C.
3. Clean the atomizing nozzle with hot water after each use and clean with a mild detergent after the last treatment of the day.
 **Caution!** During cleaning procedure, do not press on the ultrasonic membrane, because it can be permanently damaged.

Filter change

1. Do not use cotton or any other materials. Do not wash or clean the filter. Only use filters supplied by your distributor. And do not operate without a filter.
2. Change the filter every 30 days or when it turns grey.
3. Changing procedure:
 - a) Remove the filter cover
 - b) Replace the used filter with a new one
 - c) Replace the filter cover

How to preserve the effectiveness of your device

1. Your M480 ultrasound system for aerosol therapy does not require any particular maintenance care; you only need to:
 - avoid hitting or dropping it;
 - avoid opening it under any circumstances;
 - keep it in a suitable place, avoiding high temperatures, direct sunlight, humidity and dust;
 - avoid using the device for more than 30 minutes uninterruptedly.
2. After all sessions, carefully clean all the accessories used. Accessories may be washed under running water. If you want to sterilize them, a cold solution suggested by your family doctor may be used.
3. We recommend performing a maximum of 2 treatments using a single medicinal holder (cup) before replacing it.
4. We strongly recommend replacing the air filter after 15/20 treatments, or when the filter becomes grey. For the substitution, proceed as follows:
 - remove the cap from its slot under the base of the device;
 - remove the old filter and introduce the new one;
 - replace the cap inside its slot.

Technical features

Name and model number	Mediblink Ultrasonic Nebulizer M480, Model: ULTRANEB DESK 2
Power	100–240 VAC 50/60 Hz, 0.6 A
Ultrasonic Frequency	2.4 MHz \pm 50 kHz
Nebulization rate (NaF)	MIN: 0.4–0.64 ml/min MED: 0.6–0.8 ml/min MAX: 0.65–0.9 ml/min
Particle Size MMAD (NaF)	1.19-1.52 μ m, depending on nebulization rate setting
Medicine Cup Capacity	Approximately 10 ml maximum
Noise level	32,9 dB
Dimensions	164 x 97 x 140 mm
Weight	Approximately 425 g
Operating Temperature and Humidity	10 °C to 40 °C (50 °F to 104 °F); 10 to 85 % RH
Temperature and Humidity of Storage and Transportation	-20 °C to 70 °C (-4° to 158° F); 10 to 95 % RH

Figure 1: the distribution of atomized particles (Albuterol sulfate)

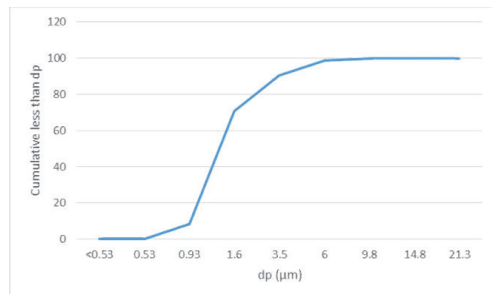

The above technical features may be subject to change at the discretion of the producer.

Troubleshooting

If any abnormality occurs during use, please check and correct the following:

Condition	Correction
Unit does not operate when the ON/OFF button is pressed.	Check the AC adapter connection to the outlet and/or check the AC plug in the unit's AC port. Check whether the water tank is filled to the correct level.
No misting or a low rate of misting	Check whether there is medication in the medication cup. Check the medication cup for damage. Check whether the transducer is clean.
Fan is not working properly	Device must be sent to authorized service company to check whether the fan is firmly and properly mounted on the motor shaft.

EMC Declaration

Guidance and manufacturer's declaration – electromagnetic emission		
This device is intended for use in the electromagnetic environment specified below. The customer of the user of the device should ensure that it is used in such an environment.		
Emission test	Compliance	Electromagnetic environment – guidance
RF emissions CISPR 11	Group 1	The device is suitable for use in all establishments, other than domestic and those directly connected to the public low-voltage power supply network that supplies buildings used for domestic purposes.
RF emissions CISPR 11	Class B	
Harmonic emissions IEC 61000-3-2	Compliant	
Voltage fluctuations / flicker emissions IEC 61000-3-3	Compliant	

EMC Declaration

Guidance and manufacturer's declaration – electromagnetic immunity			
This device is intended for use in the electromagnetic environment specified below. The customer or the user of the device should ensure that it is used in such an environment.			
Immunity test	IEC 60601 test level	Compliance level	Electromagnetic environment – guidance
Electrostatic discharge (ESD) covered IEC 61000-4-2	Contact: +8 kV Air: +2,+4,+8,+15 kV	Contact: +8 kV Air: +2,+4,+8,+15 kV	Floors should be wood, concrete or ceramic tile. If the floor is with synthetic material, the relative humidity should be at least 30%.
Electrical fast transient/burst IEC 61000-4-4	The input a.c. power ports: ± 2 kV The input d.c. power ports: ± 2 kV Signal input/output ports: ± 1 kV	The input a.c. power ports: ± 2 kV The input d.c. power ports: ± 2 kV Signal input/output ports: ± 1 kV	The mains power quality should be that of a typical commercial or hospital environment.
Surge IEC 61000-4-5	Input power ports: +0.5,+1.0 kV Signal input/output: +2.0 kV	Input power ports: +0.5, +1.0 kV Signal input/output: +2.0 kV	The mains power quality should be that of a typical commercial or hospital environment.
Voltage dips, short interruptions and voltage variations in power supply input lines IEC 61000-4-11	0.5 cycles for >95% (sync angle (degrees):0, 45, 90, 135, 180,225, 270, 315) 1 cycles for >95% UT (sync angle (degrees):0) 25 (50Hz)/30 (60Hz) cycles for 30% U T (sync angle (degrees):0) 250 (50Hz)/300 (60Hz) cycles for >95% UT (sync angle (degrees):0)	0.5 cycles for >95% (sync angle (degrees):0, 45, 90, 135, 180,225, 270, 315) 1 cycles for >95% UT (sync angle (degrees):0) 25 (50Hz)/30 (60Hz) cycles for 30% U T (sync angle (degrees):0) 250 (50Hz)/300 (60Hz) cycles for >95% UT (sync angle (degrees):0)	The mains power quality should be that of a typical commercial or hospital environment. If the user of the device requires continued operation during mains interruptions, it is recommended that the device be powered using an uninterruptible power supply or a battery.
Power frequency (50Hz/60Hz) magnetic field IEC 61000-4-8	30 A/m	30 A/m	Power frequency magnetic fields should be at levels characteristic of a typical location in a typical commercial or hospital environment.
NOTE: UT is the a.c. mains voltage prior to the application of the test level.			

EMC Declaration

Guidance and manufacturer's declaration – electromagnetic immunity			
This device is intended for use in the electromagnetic environment specified below. The customer or the user of the device should ensure that it is used in such an environment.			
Immunity test	IEC 60601 test level	Compliance level	Electromagnetic environment – guidance
<p>Conducted RF IEC 61000-4-6</p>	<p>3 Vrms 150 kHz to 80 MHz</p>	<p>Same as left</p>	<p>Portable and mobile RF communications equipment should be used no closer to any part of the device, including cables, than the recommended separation distance calculated using the equation applicable to the frequency of the transmitter.</p> <p>Recommended separation distance $d = 1,2 \sqrt{P}$ $d = 1,2 \sqrt{P}$ 80 MHz to 800 MHz</p> <p>Where P is the maximum output power rating of the transmitter in watts (W) according to the transmitter manufacturer and <i>d</i> is the recommended separation distance in metres (m).</p>
<p>Radiated RF IEC 61000-4-3</p>	<p>Professional healthcare environment: 3 V/m</p> <p>Home healthcare environment: 10 Vm 80 MHz to 2700 MHz</p>	<p>Same as left</p>	<p>Field strengths from fixed RF transmitters, as determined by an electromagnetic site survey,^a should be less than the compliance level in each frequency range.^b</p> <p>Interference may occur in the vicinity of equipment marked with the following symbol: </p>
NOTE 1: At 80 MHz and 800 MHz, the higher frequency range applies.			
NOTE 2: These guidelines may not apply in all situations. Electromagnetic propagation is affected by absorption and reflection from structures, objects and people.			
a Field strengths from fixed transmitters, such as base stations for radio (cellular/cordless telephones and land mobile radios, amateur radio, AM and FM radio broadcast and TV broadcast cannot be predicted theoretically with accuracy. To assess the electromagnetic environment due to fixed RF transmitters, an electromagnetic site survey should be considered. If the measured field strength in the location in which the device is used exceeds the applicable RF compliance level above, the device should be observed to verify normal operation. If abnormal performance is observed, additional measures may be necessary, such as re-orienting or relocating the device.			
b Over the frequency range of 150 kHz to 80 MHz, field strengths should be less than 3.			

EMC Declaration

Recommended separation distances between portable and mobile RF communications equipment and the device.			
<p>The device is intended for use in an electromagnetic environment in which radiated RF disturbances are controlled. The customer or the user of the device can help prevent electromagnetic interference by maintaining a minimum distance between portable and mobile RF communications equipment (transmitters) and the device as recommended below, according to the maximum output power of the communications equipment.</p>			
Rated maximum output power of the transmitter (W)	Separation distance according to the frequency of the transmitter (m)		
	150 KHz to 80 MHz $d = 1,2 \sqrt{P}$	80 MHz to 800 MHz $d = 1,2 \sqrt{P}$	800 MHz to 2.7GHz $d = 2,3 \sqrt{P}$
0.01	0.12	0.12	0.23
0.1	0.38	0.38	0.73
1	1.2	1.2	2.3
10	3.8	3.8	7.3
100	12	12	23
<p>For transmitters rated with a maximum output power not listed above, the recommended separation distance d in metres (m) can be estimated using the equation applicable to the frequency of the transmitter, where P is the maximum output power rating of the transmitter in watts (W) according to the transmitter manufacturer.</p> <p>NOTE 1 At 80 MHz and 800 MHz, the separation distance for the higher frequency range applies.</p> <p>NOTE 2 These guidelines may not apply in all situations. Electromagnetic propagation is affected by absorption and reflection from structures, objects and people.</p>			

Warranty

Product: Mediblink Ultrasonic Nebulizer M480

Manufacturer: Foshan City Shunde Toplife Electronic Technology Co., Ltd
7F, 6BLG, Zhifu Industrial Zone, Xingtan Town, Shunde District, Foshan City, Guangdong Province, 528325, P.R. China

Sellers name, address, signature and stamp:

Date of extradition/sales:

WARRANTY TERMS

Dear Costumers!

The warranty period is 3 years and starts from the day of product purchase. The warranty is valid only for products purchased in Slovenia. In case of product claim, you have to show the invoice. We kindly ask you to save the invoice!

Unfortunately, wrong handling with the device is a reason for 95% of customer complains. You can easily avoid any problem, by getting useful information provided by our special service department. To reach our service department, you can call us on +386 (0)7 30 44 555 or send us an e-mail on servis@prolat.si.

Before sending the product back to retailer, we kindly ask you to call our service department, to get help about how to use the device to save you with unneeded trips.

The manufacturer guarantees free elimination of all imperfections due to defects in material or manufacturing procedure by repairing or replacing the product. In case that the product can not be repaired or replaced, the customer will get the money refund. The guarantee is not valid in case of the force majeure, accidents or unexpected events (such as lightning, water, fire etc.), incorrect use or incorrect transport, non-compliance with safety and maintaining regulations or in case of unprofessional product intervention.

Traces of every day product usage (scratches, abrasions) and not subject to claim. The warranty does not eliminate the customer rights, which originate from seller responsibility for product flaws. By accepting the claimed product by the service department, the service department does not take responsibility for loss of saved data or settings on the product. All product repairs, which are performed out of product warranty period, have to be paid by customer by prior notice.

The manufacturer guarantees the product quality and flawless product operation in the warranty period, which starts with the day of product purchase. If the product can not be repaired in 45 days, the product will be replaced with a new one. In case that the product can not be replaced, the money will be refunded to the customer.

The warranty period on spare parts: masks, mouthpiece, tube and filters is 1 year.

In case of product claim, call us on +386 (0)7 30 44 555 or send us an e-mail on servis@prolat.si.

Any serious incident that has occurred in relation to the device should be reported to the Manufacturer and the Competent Authority of the Member State in which the user and/or patient is established.

Exclusive representative for Slovenia:
 Prolat d.o.o.
 Praproče 9
 8210 Trebnje - SLO
 Tel: +386-(0)7-30-44-555
 info@prolat.si
 Service and claims: servis@prolat.si
 www.prolat.si

Manufactured for
 (EU importer):
 Mediblink d.o.o.
 Gubčeva cesta 19
 8210 Trebnje
 Slovenia
 info@mediblink.com
 www.mediblink.com

Exclusive representative for Croatia:
 Golia d.o.o.
 XI Vrbik 3
 10000 Zagreb
 Tel: (01) 61-98-496
 info@golia.hr
 Service and claims: servis@golia.hr
 www.golia.hr



Foshan City Shunde Toplife Electronic Technology Co., Ltd
 7F, 6BLG, Zhifu Industrial Zone, Xingtan Town,
 Shunde District, Foshan City,
 Guangdong Province, 528325, P.R. China



Lotus NL B.V.
 Koningin Julianaplein 10, 1e Verd, 2595AA,
 The Hague, Netherlands
 Tel: +31644168999 Email: peter@lotusnl.com

CE
1639

Instructions for use version number.: A/8
 Instruction for use issue date: 01.02.2020
 Date of last correction: 22.09.2021
 Software version: V1.0
 Document number: HSH-CE-01-016
 SRN: CN-MF-000002235

Uvod

Spoštovani kupec!

Zahvaljujemo se Vam, da ste izbrali izdelek Mediblink Ultrazvočni inhalator M480, napravo za aerosolno terapijo, oblikovano in izdelano z uporabo najnaprednejše tehnologije.

Za lažjo uporabo Vam predlagamo, da sledite navodilom za pripravo in uporabo ultrazvočnega inhalatorja Mediblink M480.

Mediblink Ultrazvočni inhalator M480 je medicinski pripomoček tipa IIa, ki pretvori zdravilo oz. sterilno fiziološko raztopnino iz tekoče oblike v aerosole, le-te pa razprši naravnost v respiratorni trakt (dihalno pot).

Mediblink Ultrazvočni inhalator M480 omogoča, da razpršeni delci oz. aerosoli zaradi svoje majhnosti prodrejo v zgornje in spodnje dihalne poti.

Opozorilo!

Ta izdelek mora sestaviti, vzdrževati in uporabljati odrasla oseba. Med uporabo izdelka otrok nikoli ne pustite brez nadzora: izdelek vsebuje majhne delce, ki jih je mogoče pogoltniti. Izdelek mora biti na razpolago samo za čas, ko izvajate terapijo. Po končani terapiji morate izdelek shraniti na varno mesto, izven dosega otrok. Svetujemo vam, da pred uporabo preberete kratek seznam opozoril, ki je podan v teh navodilih, in se prepričate, da popolnoma razumete delovanje naprave.

Dodatki

Pripomoček vključuje naslednje dele, ki so priloženi v polietilenski ovojnici, priloženi pripomočku.

Seznam dodatkov

Št.	sestavnega dela	Št. modela	Št. artikla	Material	Količina
1	Maska za odrasle	PNEMAD	180-S08MZ7	PVC+PP	1
2	Pediatrična maska	PNEMIN	180-S09MZ8	PVC+PP	1
3	Posodica za zdravilo	PNEBCAM3	XC-S02YB	PVC	10
4	Tesnilni obroč	PNEBUANL	180-G02DQ	Silikon	3
5	Cevni podaljšek	PNEBTUB3	180-S06SSG1	PP	1
6	Adapter	RSS1006-180240-W2B-H	180-D02SPQ	/	1
7	Ustnik	PNEMOU	180-S01YZ	PP	1
8	Nosni nastavek	PNEBNOS	180-S08BC7	PP	1

Slika 1: Dodatki inhalatorja

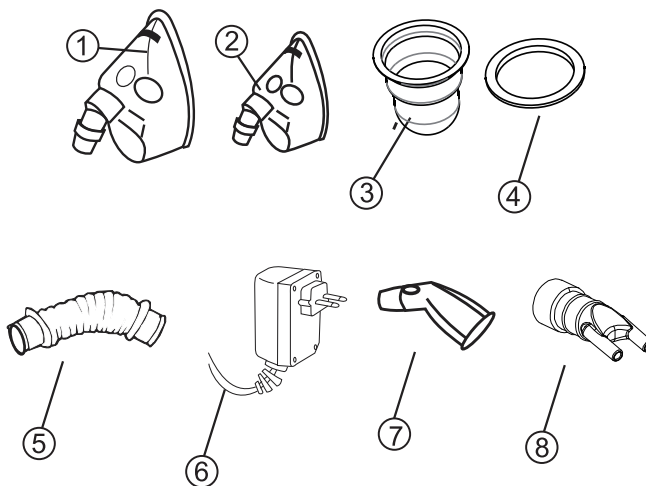

Sestavni deli inhalatorja

Vaš ultrazvočni sistem Mediblink M480 za terapijo z razpršilom.

Slika 2: Sestavni deli inhalatorja

- 1 – Razpršilna šoba
- 2 – Posodica za zdravilo
- 3 – Tesnilni obroč
- 4 – Senzor ravni vode
- 5 – Telo naprave z vsebnikom za vodo
- 6 – Stikalo
- 7 – Opozorilna lučka

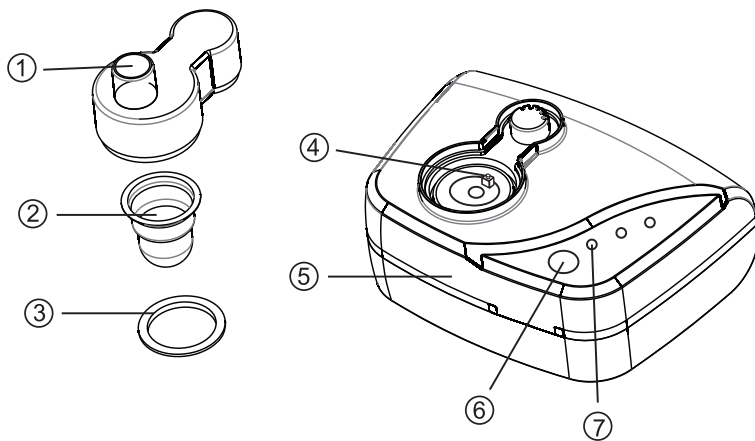

Uvod

Predvidena uporaba: Ultrazvočni nebulator za odrasle in otroke, ki so pri zavesti, je namenjen za pretvorbo tekočega albuterol sulfata ali sterilne fiziološke raztopine v razpršilo za inhaliranje.

Kontraindikacija: Nikoli ne uporabljajte pri nezavestnih bolnikih.

Ciljna uporabniška skupina: Pravno certificirani zdravstveni strokovnjaki, kot so zdravnik, medicinska sestra in terapevt ali zdravstveno osebje ali bolnik pod vodstvom usposobljenih zdravstvenih strokovnjakov za zdravljenje na domu.

Zdravstvena stanja, ki jih zdravi:

Pripomoček, namenjen za zdravljenje astme, KOPB in drugih bolezni dihal, pri katerih je med zdravljenjem potrebna terapija z zdravili ali s sterilno fiziološko raztopino v obliki aerosolov.

Življenjska doba pripomočka je 5 let.

Opozorila in previdnostni ukrepi, previdnosti ukrepi med uporabo

1. Pazite, da razpršilo z zdravilnimi učinkovinami ne zaide v vaše oči. Po vsaki uporabi zamenjajte vodo.
2. Največja prostornina posodice za zdravilo je 10 ml, posodice pa ne smete preveč napolniti.
3. Gosta zdravila ali volumen zdravil 2 ml ali manj razredčite z destilirano vodo ali fiziološko raztopino, da dobite volumen najmanj 4 ml.
4. Te enote ne uporabljajte med upravljanjem vozila.
5. Če se pojavi kakršno koli neugodje ali anomalija, enoto nemudoma prenehajte uporabljati.

⚠ Opozorila

1. Inhalatorja ne izpostavljajte: visokim temperaturam, vlagi, prahu ali neposredni svetlobi.
2. Pripomoček ne sme pasti ali udariti ob druge predmete.
3. Da bi se izognili okužbam in drugim boleznim, masko, posodico za zdravilo in cevni podaljšek uporabite samo enkrat.
4. V vsebnik za vodo ne napolnite večje količine, kot je navedeno v navodilih.
5. Če inhalatorja ne uporabljate, v inhalacijski komori ne puščajte zdravila.
6. Inhalator pred čiščenjem, polnjenjem z zdravilom in po vsaki uporabi izključite iz električne vtičnice.
7. Inhalator uporabljajte s premori; to pomeni, da po 20 minutah prenehajte z uporabo za 40 minut in ga nato po potrebi spet uporabite za 20 minut.
8. Inhalatorja nikoli ne umivajte, namakajte ali potaplajte v vodo ali katero koli drugo tekočino. Za čiščenje sledite natančnim navodilom v poglavju VZDRŽEVANJE IN ČIŠČENJE v tem priročniku.
9. Inhalatorja ne uporabljajte z mokrimi rokami, saj ga lahko poškodujete, poškodbe pa lahko utrpi tudi uporabnik.
10. Enote ne uporabljajte, če ima poškodovane dele (vključno z napajalnim kablom), če vam je padla na tla ali če je bila potopljena v vodo. Takoj jo pošljite tehnikom, da jo preizkusijo in popravijo.
11. Otroci inhalatorja ne smejo uporabljati brez nadzora odrasle osebe.
12. Inhalatorja ne upogibajte, saj lahko pride do uhajanja zdravila in okvare.
13. Prosimo, uporabite masko za odrasle in pediatrično masko, ki imata ustrezen certifikat CE in številko priglašenelega organa.
14. Dodatki so primerni za enkratno uporabo, in jih ni dovoljeno uporabiti večkrat. Če potrebujete nove dodatke, se obrnite na podjetje, ki je zastopnik za Mediblink v vaši državi.
15. Iz higienskih razlogov mora vsak uporabnik uporabiti svoje dodatke in samo take za enkratno uporabo.

Izhod razpršila NaF

1. Preizkusna metoda

- a) Uporabljen je bil zrak.
- b) Inhalator je bil napolnjen s testiranim zdravilom (2 ml NaF 1,0 % (M/V) in uporabljenimi stopnjami pretoka 2 l/min) za preizkus hitrosti in količine izhoda razpršila.
- c) Izhod razpršila, izražen v mililitrih NaF 1,0 % (M/V).
- d) Inhalator je bil napolnjen s testiranim zdravilom (2 ml NaF 2,5 % (M/V) in uporabljenim pretokom 2 l/min) za preizkus velikosti delcev.

Izhod razpršila NaF

2. Rezultati preizkusa NaF (najmanjša hitrost)

Preglednica 1: Povzetek rezultatov preizkusa za predlagani pripomoček (M480)

Test	Features	
Particle sizing	Total output particle mass (M_1 , μg)	26273.36 \pm 3410.11
	Particle mass collected by the cascade impactor (M_2 , μg)	354.63 \pm 15.38
	Particle mass collected by the outlet filter (M_3 , μg)	2228.35 \pm 108.35
	MMAD (μm)	1.52 \pm 0.1
	C.V. for the MMAD between four tests (%)	6.38
	Geometric Std. Dev. (GSD)	1.65 \pm 0.16
	C.V. for the GSD between four tests (%)	9.89
	Respirable fraction (% 0.5-5 μm)	93.49 \pm 0.9
	Respirable Mass (μg 0.5-5 μm)	331.61 \pm 17
	Treatment time (min)	1
	Course particle Fraction (%) (> 4.7 μm)	6.89 \pm 1.22
	Fine particle Fraction (%) (< 4.7 μm)	93.11 \pm 1.22
	Ultra-fine particle Fraction (%) (< 1 μm)	13.33 \pm 4.56
Aerosol output and aerosol output rate	Aerosol output (ml^a)	2.06 \pm 0.13
	Aerosol output rate (ml/min^b)	0.6 \pm 0.04

a : Continue the treatment until the medicine cup is empty or the mist stops.

b : The treatment time for aerosol output rate is 1 min.

Preglednica 2: Masni delež zdravila, zbranega na vsaki stopnji impaktorja Marple

stage No.	Effective cutoff dia. (μm)	Cumulative fraction (%)					Mean collected mass per minute for each stage (μg)	Mean mass fraction for each stage (%)
		Test 1	Test 2	Test 3	Test 4	Mean		
1	21.3	100.00	100.00	100.00	100.00	100.00	9.40	2.65
2	14.8	97.30	97.27	97.41	97.41	97.35	9.55	2.69
3	9.8	94.13	94.87	94.93	94.66	94.65	10.90	3.07
4	6	91.07	91.64	92.00	91.58	91.57	33.85	9.55
5	3.5	79.45	83.50	83.05	81.98	82.00	85.10	24.00
6	1.6	52.85	60.81	59.54	58.59	57.95	186.20	52.51
7	0.93	11.92	0.00	6.73	3.99	5.66	19.28	5.44
8	0.53	0.30	0.00	0.11	0.00	0.10	0.35	0.10
after filter	<0.53	0.00	0.00	0.00	0.00	0.00	0.00	0.00
Total							354.63	

Slika A: Prikaz kumulativne porazdelitve velikosti rezultatov v preglednici 2

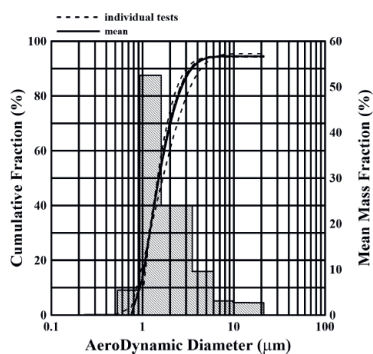

Reference

Rubow, K. L., Marple, V. A., Olin, J., and McCawley, M. A., 1987, "A Personal Cascade Impactor: Design, Evaluation and Calibration", *Am. Ind. Hyg. Assoc. J.* (48): 532-538.

Izhod razpršila NaF

3. Rezultati preizkusa NaF (srednja hitrost)

Preglednica 3: Povzetek rezultatov preizkusa za pripomoček (M480)

Test	Features	
Particle sizing	Total output particle mass (M_1 , μg)	32055.23 \pm 1531.12
	Particle mass collected by the cascade impactor (M_2 , μg)	304.15 \pm 10.46
	Particle mass collected by the outlet filter (M_3 , μg)	1436.3 \pm 515.7
	MMAD (μm)	1.39 \pm 0.06
	C.V. for the MMAD between four tests (%)	4.52
	Geometric Std. Dev. (GSD)	1.73 \pm 0.05
	C.V. for the GSD between four tests (%)	2.84
	Respirable fraction (% 0.5-5 μm)	95.92 \pm 1.04
	Respirable Mass (μg 0.5-5 μm)	291.67 \pm 7.54
	Treatment time (min)	1
	Coarse particle Fraction (%) ($>$ 4.7 μm)	4.48 \pm 1.14
Fine particle Fraction (%) ($<$ 4.7 μm)	95.52 \pm 1.14	
Ultra-fine particle Fraction (%) ($<$ 1 μm)	26.06 \pm 2.12	
Aerosol output and aerosol output rate	Aerosol output (ml) ^a	2.16 \pm 0.21
	Aerosol output rate (ml/min) ^b	0.67 \pm 0.07

a : Continue the treatment until the medicine cup is empty or the mist stops.

b : The treatment time for aerosol output rate is 1 min.

Preglednica 4: Masni delež zdravila, zbranega na vsaki stopnji impaktorja Marple

stage No.	Effective cutoff dia. (μm)	Cumulative fraction (%)					Mean collected mass per minute for each stage ($\mu\text{g}/\text{min}$)	Mean mass fraction for each stage (%)
		Test 1	Test 2	Test 3	Test 4	Mean		
1	21.3	100.00	100.00	100.00	100.00	100.00	4.00	1.32
2	14.8	98.27	99.12	98.60	98.78	98.69	3.05	1.00
3	9.8	96.80	98.71	97.45	97.83	97.70	9.80	3.22
4	6	93.09	96.00	94.20	94.65	94.48	23.35	7.68
5	3.5	83.31	90.09	85.97	88.02	86.85	75.33	24.77
6	1.6	59.27	64.52	61.93	62.53	62.06	129.20	42.48
7	0.93	16.69	22.18	20.06	19.36	19.57	59.07	19.42
8	0.53	0.32	0.00	0.13	0.00	0.11	0.35	0.12
after filter	<0.53	0.00	0.00	0.00	0.00	0.00	0.00	0.00
Total							304.15	

Slika B: Prikaz kumulativne porazdelitve velikosti rezultatov v preglednici 4

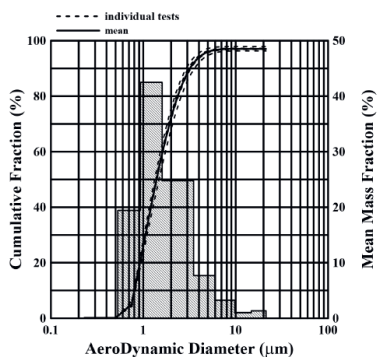

Reference

Rubow, K. L., Marple, V. A., Olin, J., and Mccawley, M. A., 1987, "A Personal Cascade Impactor: Design, Evaluation and Calibration", *Am. Ind. Hyg. Assoc. J.* (48): 532-538.

Izhod razpršila NaF

4. Rezultati preizkusa NaF (največja hitrost)

Preglednica 5: Povzetek rezultatov preizkusa za pripomoček (M480)

Test	Features	
Particle sizing	Total output particle mass (M_1 , μg)	23967.07 \pm 1633.28
	Particle mass collected by the cascade impactor (M_2 , μg)	256.75 \pm 136.63
	Particle mass collected by the outlet filter (M_3 , μg)	1488 \pm 426.33
	MMAD (μm)	1.19 \pm 0.18
	C.V. for the MMAD between four tests (%)	15.27
	Geometric Std. Dev. (GSD)	1.72 \pm 0.28
	C.V. for the GSD between four tests (%)	16.04
	Respirable fraction (% 0.5-5 μm)	96.43 \pm 2.09
	Respirable Mass (μg 0.5-5 μm)	245.52 \pm 128.01
	Treatment time (min)	1
	Coarse particle Fraction (%) (> 4.7 μm)	3.85 \pm 2.3
Fine particle Fraction (%) (< 4.7 μm)	96.15 \pm 2.3	
Ultra-fine particle Fraction (%) (< 1 μm)	41.04 \pm 13.1	
Aerosol output and aerosol output rate	Aerosol output (ml) ^a	2.15 \pm 0.04
	Aerosol output rate (ml/min) ^b	0.66 \pm 0.01

a : Continue the treatment until the medicine cup is empty or the mist stops.

b : The treatment time for aerosol output rate is 1 min.

Preglednica 6: Masni delež zdravila, zbrana na vsaki stopnji impaktorja Marple

stage No.	Effective cutoff dia. (μm)	Cumulative fraction (%)					Mean collected mass per minute for each stage ($\mu\text{g}/\text{min}$)	Mean mass fraction for each stage (%)
		Test 1	Test 2	Test 3	Test 4	Mean		
1	21.3	100.00	100.00	100.00	100.00	100.00	5.05	1.97
2	14.8	100.00	97.66	98.32	97.80	98.45	3.25	1.27
3	9.8	100.00	96.14	97.17	96.45	97.44	5.90	2.30
4	6	100.00	93.40	95.31	93.83	95.63	18.00	7.01
5	3.5	97.25	85.89	88.04	86.55	89.43	51.45	20.04
6	1.6	94.50	63.91	68.73	64.12	72.82	94.30	36.73
7	0.93	50.50	28.83	30.12	28.48	34.48	78.25	30.48
8	0.53	1.50	0.00	0.09	0.24	0.46	0.55	0.21
after filter	-0.53	0.00	0.00	0.00	0.00	0.00	0.00	0.00
Total							256.75	



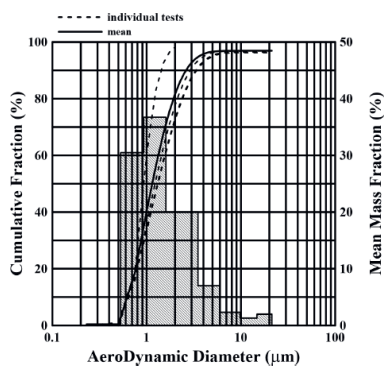







Slika C: Prikaz kumulativne porazdelitve velikosti rezultatov v preglednici 6















Reference

Rubow, K. L., Marple, V. A., Olin, J., and Mccawley, M. A., 1987, "A Personal Cascade Impactor: Design, Evaluation and Calibration", *Am. Ind. Hyg. Assoc. J.* (48): 532-538.

Uporabljeni simboli

Simboli	Pomeni simbolov
	Uporabljeni del tipa BF
	Oprema razreda II
	Preberite navodila za uporabo http://www.mediblink.com/f/m480.pdf
	Proizvajalec
	Datum proizvodnje
	Pooblaščen predstavnik v Evropski skupnosti
	Medicinski pripomoček
	Koda serije*
	Serijska številka
	Rok uporabnosti
	Označevanje električnih in elektronskih naprav je v skladu z Direktivo 2002/96/ES. Pripomoček, dodatke in embalažo je treba ob koncu uporabe pravilno odstraniti med odpadke. Upoštevajte lokalne odloke ali predpise za odstranjevanje med odpadke.

Simboli	Pomeni simbolov
	Nesterilno
	Ni primerno za večkratno uporabo
	Oznaka CE
IP21	Zaščiteno pred trdnimi tujimi predmeti premera 12,5 mm ali več
	Število izdelkov v enem pakiranju
	Mejna vrednost temperature shranjevanja
	Mejna vrednost vlažnosti pri shranjevanju
	Mejna vrednost zračnega tlaka shranjevanja
	Ta stran navzgor
	Krhko, ravnati previdno
	Pazite, da se ne zmoči
	Omejitev zlaganja na 6
	Pozor!

*Datum proizvodnje: prvi par LOT številke predstavlja mesec proizvodnje, drugi par predstavlja leto proizvodnje. Npr.: LOT 1025 = oktober 2025.

Sledite natančnim navodilom za uporabo, ki so navedena v tem priročniku, in ne uporabljajte inhalatorja v obliki, ki ni opisana v tem priročniku (na primer z dodatki, ki jih ni dovolil proizvajalec, z vstavljenimi predmeti ali odprtega), saj s tem tvegate nezgode in izgubo garancije.



POZOR – Navodila za pravilno odstranjevanje izdelka med odpadke

Ta simbol pomeni, da izdelka po uporabi ni dovoljeno odložiti med gospodinjske odpadke, temveč ga je treba med odpadke odstraniti v skladu z veljavnimi zakonskimi določbami, da se preprečijo negativne posledice za zdravje in okolje.

Previdnostni ukrepi za shranjevanje

Enote ne shranjujte na neposredni sončni svetlobi, visoki temperaturi ali vlagi.

Enoto hranite zunaj dosega majhnih otrok.

Ko enote ne uporabljate, jo morate vedno odklopiti.

Navodila

1. Pred uporabo tega pripomočka se posvetujte s svojim družinskim zdravnikom.
2. Pripomoček hranite zunaj dosega otrok.
3. Ko je terapija končana, pripomoček izključite tako, da vtič izvlečete iz vtičnice.

Za pravilno uporabo in čas vzdrževanja vašega novega sistema za terapijo z razpršilom priporočamo, da pozorno preberete naslednje indikacije.

Kako uporabljati sistem M480 za terapijo z razpršilom

Prepričajte se, da sta pripomoček in vsi uporabljeni dodatki čisti, nato pa zaporedoma nadaljujte z naslednjimi postopki:

1. Pripomoček postavite na stabilno, golo ravno površino (miza brez prta ali drugega pregrinjala) v bližini napajanja.
2. Odprite pokrov naprave.
3. Odstranite zgornji del, kot je prikazano na sliki 1.
4. Vsebnik za vodo napolnite s hladno vodo iz pipe (destilirana voda ali filtrirana voda nista primerni za uporabo) in si pri tem pomagajte z majhno posodo, kot je prikazano na sliki 2. Napolnite do ravni, ki je označena v vsebniku za vodo (slika 9): voda omogoča prevajanje ultrazvočnih valov v zdravilo in ni namenjena inhaliranju.
5. Vzemite posodico za zdravilo z zdravilom, kot je prikazano na sliki 3.
6. Namestite tesnilni obroč na odprtino vsebnika za vodo, preden vanjo namestite posodico za zdravilo.
7. Posodico za zdravila z zdravilom vtaknite v namensko režo pod zgornjim delom pripomočka (slika 4), ne da bi se zdravilo pri tem razlilo iz posode.
8. Pazljivo združite oba dela na zgornjem delu pripomočka.
9. Povežite konektor s cevnim podaljškom; nato prosti konec konektorja povežite z masko za inhaliranje zdravila (slika 5). Izberite eno od dveh mask ali ustnik ali nosnik glede na zahtevano zdravljenje in izbrani način dovajanja zdravila.
10. Napajalni kabel vtaknite v vtičnico na zadnji strani pripomočka.
11.  Opozorilo! V odvod zraka ne sme pod nobenim pogojem zaiti voda. Oglejte si sliko 8.
12. Upoštevajte oznako za raven vode v vsebniku za vodo (oglejte si sliko 9). V vsebnik za vodo napolnite vodo iz pipe. Destilirana voda in filtrirana voda nista primerni za uporabo, saj senzor z njima ne more delovati.

Pripomoček je zdaj pripravljen za uporabo.

Navodila

Kako izvajati terapijo z razpršilom

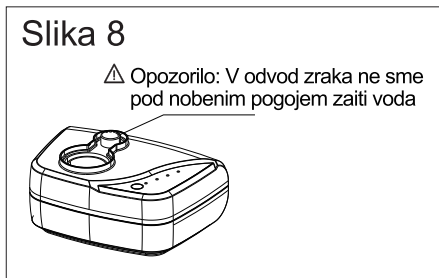
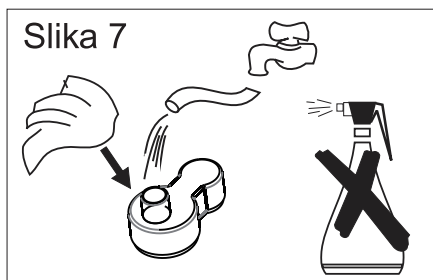
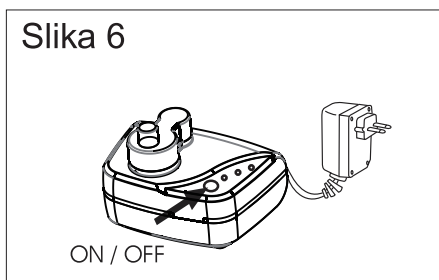
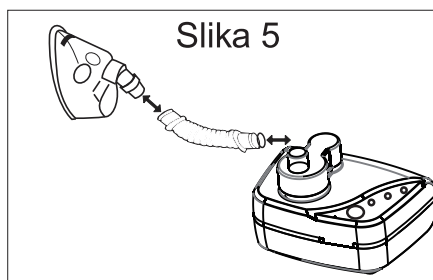
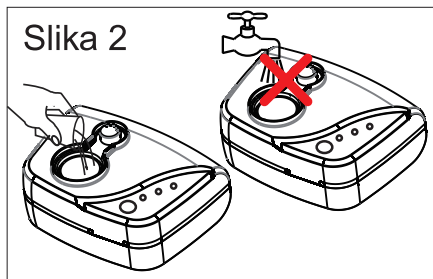
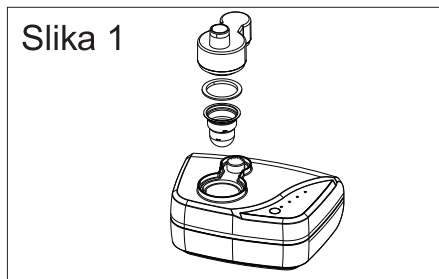

Navodila

1. Napajalni kabel vtaknite v ustrezno vtičnico (oglejte si etiketo na spodnji strani pripomočka).
2. Pritisnite stikalo na vrhu pripomočka: opozorilna lučka na vrhu zasveti (zelena lučka), kar pomeni, da pripomoček pravilno deluje.
3. Začnete s terapijo in pripomoček med celotnim trajanjem terapije držite v navpičnem položaju, da zagotovite pravilno delovanje in največjo učinkovitost pripomočka.
4. Hitrost nebuliranja zdravila lahko nadzirate z izbiro »MIN«, »MID« in »MAX«.
Svetujemo, da predvsem pri zdravljenju otrok obrnete gumb v položaj »MIN«, da bo večji delež aerosolov dosegel dihalne poti.
5. Nadaljujte s terapijo, dokler ne opazite rahle meglice (inhaliranje zdravila, ki ga povzroči pripomoček).
6. Po vsakem tretmaju je treba vodo v vsebniku za vodo izprazniti, ter prostor obrisati z mehko, čisto, suho krpo. Pred naslednjo terapijo je potrebno ponovno v vsebnik naliti vodo.

⚠ Pozor: običajno ostane po koncu terapije v notranjosti posodice za zdravilo majhna količina zdravila: te količine, imenovane preostali volumen, ni mogoče inhalirati.

Po koncu terapije:

1. Pripomoček izklopite s pritiskom stikala.
2. Napajalni kabel izključite iz električnega napajanja.
3. Napajalni kabel izključite iz vtičnice na zadnji strani pripomočka.
4. Moder konektor odstranite s telesa, in odstranite masko (ali drug dodatek) s konca cevnega podaljška.
5. Moder konektor odstranite s podaljševalne cevke.
6. Posodico za zdravila in tesnilo odstranite s telesa pripomočka.
7. Odstranite vodo iz vsebnika za vodo.
8. Vsebnik za vodo previdno obrišite z mehko krpo in se prepričajte, da je vsebnik za vodo in moder konektor popolnoma suh.
9. Posodico za zdravila, tesnilo in moder konektor znova namestite na telo pripomočka.
10. Vse dodatke shranite v škatlo skupaj s pripomočkom.

Čiščenje in vzdrževanje

Previdnostni ukrepi:

Pred vsako uporabo preverite posodico z zdravilom in zračni filter. Umazane ali obrabljene dele zamenjajte. Enote ne potaplajte v vodo.

Pomembno je, da ultrazvočni nebulator pred prvo uporabo in po vsaki uporabi očistite. Enote ne pozabite odklopiti iz električne vtičnice. Enote nikoli ne potaplajte v vodo. Enota se lahko pri tem poškoduje.

Ne uporabljajte čistil v prahu ali abrazivnih čistil, ki bi lahko poškodovala končni premaz.

Čiščenje pripomočka

1. Pred čiščenjem enoto izključite iz električne vtičnice.
2. Površino glavne enote je treba očistiti z mehko krpo, navlaženo z neabrazivnim čistilnim sredstvom in vodo s temperaturo pod 30°C. Glavne enote ne postavljajte neposredno v vodo. Ultrazvočni del lahko očistite z bombažno palčko in čisto vodo s temperaturo pod 30°C.
3. Po vsaki uporabi razpršilno šobo očistite z vročo vodo in jo po zadnji terapiji očistite z blagim detergentom.
 - ⚠ **Pozor!** Med čiščenjem ne pritiskajte na membrano, ker jo tako lahko trajno poškodujete.

Menjava filtra

1. Ne uporabljajte bombaža ali drugih materialov. Ne umivajte ali čistite filtra. Uporabljajte samo filtre, ki jih dobavlja vaš distributer. Ne uporabljajte brez filtra.
2. Filter zamenjajte vsakih 30 dni ali ko filter postane siv.
3. Postopek menjave:
 - a) Odstranite pokrov filtra.
 - b) Uporabljeni filter zamenjajte z novim.
 - c) Ponovno namestite pokrov filtra.

Kako ohraniti učinkovitost vašega pripomočka

1. Ultrazvočni sistem M480 za terapijo z razpršilom ne zahteva posebnega vzdrževanja, temveč samo:
 - preprečite udarce in padce;
 - pripomočka pod nobenimi pogoji ne odpirajte;
 - hranite ga na primernem mestu, pri čemer se izogibajte visokim temperaturam, neposredni sončni svetlobi, vlagi in prahu;
 - pripomočka ne uporabljajte neprekinjeno dlje kot 30 minut.
2. Po vsaki terapiji skrbno očistite vse uporabljene dodatke. Dodatke lahko operete pod tekočo vodo. Če jih želite sterilizirati, lahko uporabite hladno raztopino po priporočilu vašega družinskega zdravnika.
3. Priporočamo, da posodico za zdravilo uporabite za največ dve terapiji in jo nato zamenjate.
4. Priporočamo, da zračni filter zamenjate po 15/20 tretmajih ali ko filter postane siv. Za zamenjavo sledite naslednjemu postopku:
 - pokrov odstranite iz reže pod telesom naprave;
 - stari filter odstranite in namestite novega;
 - zamenjajte pokrov znotraj reže.

Tehnične lastnosti

Ime in številka modela	Mediblink Ultrazvočni inhalator M480, Model: ULTRANEB DESK 2
Moč	100–240 VAC 50/60 Hz, 0,6 A
Ultrazvočna frekvenca	2,4 MHz \pm 50 kHz
Hitrost nebuliranja (NaF)	NAJM.: 0,4–0,64 ml/min SREDNJA: 0,6–0,8 ml/min NAJV.: 0,65–0,9 ml/min
Velikost delcev MMAD (NaF)	1,19–1,52 μ m, odvisno od nastavljene hitrosti razprševanja
Prostornina posodice za zdravilo	Približno 10 ml
Raven hrupa	32,9 dB
Mere	164 x 97 x 140 mm
Teža	Približno 425 g
Temperatura in vlažnost delovanja	10 °C do 40 °C (50 °F do 104 °F); od 10 do 85 % RV
Temperatura in vlažnost pri shranjevanju in med transportom	-20 °C do 70 °C (-4 °F do 158 °F); od 10 do 95 % RV

Slika 1: Porazdelitev atomiziranih delcev (albuterol sulfat)

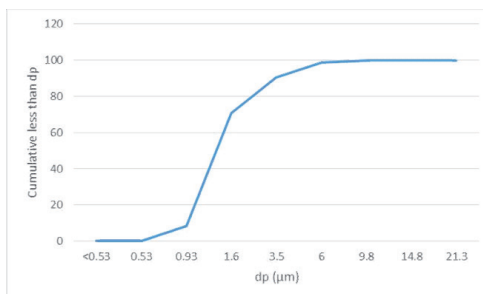

Zgoraj navedene tehnične lastnosti se lahko po presoji proizvajalca spremenijo.

Odpravljanje težav

Če se med uporabo pojavi kakršna koli nepravilnost, preverite in popravite naslednje:

Stanje	Ukrep
Enota ne deluje, čeprav je pritisnjen gumb za VKLOP/IZKLOP.	Preverite povezavo med napajalnikom in vtičnico in/ali preverite, ali je vtič vklopljen v vhod na enoti. Preverite, ali je vsebnik za vodo napolnjen do ustrezne ravni. Pri uporabi z dodatno baterijo preverite, ali je baterija povsem napolnjena.
Meglica se ne tvori ali pa se tvori zelo počasi	Preverite, ali je zdravilo v posodici za zdravilo. Preverite, ali je posodica za zdravilo poškodovana. Preverite, ali je pretvornik čist.
Ventilator ne deluje pravilno	Preverite, ali je ventilator trdno in ustrezno nameščen na gred motorja.

Izjava o elektromagnetni združljivosti

Navodila in izjava proizvajalca – elektromagnetno sevanje		
Pripomoček je namenjen uporabi v spodaj navedenem elektromagnetnem okolju. Kupec ali uporabnik pripomočka mora zagotoviti uporabo v takem okolju.		
Preskus sevanja	Skladnost	Elektromagnetno okolje – navodila
Radiofrekvenčne emisije CISPR 11	Skupina 1	Pripomoček uporablja radiofrekvenčno energijo samo za svoje notranje funkcije. Zato so njegove emisije RF zelo nizke in obstaja majhna verjetnost motenj bližnje elektronske opreme.
Radiofrekvenčno sevanje CISPR 11	Razred B	Pripomoček je primeren za uporabo povsod, razen doma in v okoljih z napravami za nekomercialno uporabo, ki so priključene neposredno na nizkonapetostno omrežje v poslopih.
Harmonične emisije IEC 61000-3-2	Skladno	
Napetostna nihanja/ flikerji IEC 61000-3-3	Skladno	

Izjava o elektromagnetni združljivosti

Navodila in izjava proizvajalca – elektromagnetna odpornost			
Pripomoček je namenjen uporabi v spodaj navedenem elektromagnetnem okolju. Kupec ali uporabnik pripomočka mora zagotoviti uporabo v takem okolju.			
Preizkus odpornosti	Raven za preizkušanje IEC 60601	Raven skladnosti	Elektromagnetno okolje – navodila
Elektrostatična razelektritev: IEC 61000-4-2	Kontakt: +8 KV Zrak: +2,+4,+8,+15 KV	Kontakt: +8 KV Zrak: +2,+4,+8,+15 KV	Tla morajo biti lesena, betonska ali prekrita s keramičnimi ploščicami. Če so tla prekrita s sintetičnim materialom, mora biti relativna vlažnost najmanj 30 %.
Hitri električni prehodni pojavi/ burst IEC 61000-4-4	Vhodi za napajanje AC: ± 2 KV Vhodi za napajanje DC: ± 2 KV Vhodi/izhodi signala: ± 1 KV	Vhodi za napajanje AC: ± 2 KV Vhodi za napajanje DC: ± 2 KV Vhodi/izhodi signala: ± 1 KV	Kakovost električnega omrežja mora biti enaka kot v tipičnem komercialnem ali bolnišničnem okolju.
Napetostni udar IEC 61000-4-5	Vhodi za napajanje: +0,5, +1,0 KV Vhodi/izhodi signala: +2,0 kV	Vhodi za napajanje: +0,5, +1,0 KV Vhodi/izhodi signala: +2,0 kV	Kakovost električnega omrežja mora biti enaka kot v tipičnem komercialnem ali bolnišničnem okolju.
Padci napetosti, kratke prekinitve in napetostna nihanja na napajalnih vodih IEC 61000-4-11	0,5 cikla za > 95 % (sinhronizacijski kot (stopinj): 0, 45, 90, 135, 180, 225, 270, 315) 1 cikel za > 95 % UT (sinhronizacijski kot (stopinj): 0) 25 (50 Hz)/30 (60 Hz) ciklov za 30 % UT (sinhronizacijski kot (stopinj): 0) 250 (50 Hz)/300 (60 Hz) ciklov za > 95 % UT (sinhronizacijski kot (stopinj): 0)	0,5 cikla za > 95 % (sinhronizacijski kot (stopinj): 0, 45, 90, 135, 180, 225, 270, 315) 1 cikel za > 95 % UT (sinhronizacijski kot (stopinj): 0) 25 (50 Hz)/30 (60 Hz) ciklov za 30 % UT (sinhronizacijski kot (stopinj): 0) 250 (50 Hz)/300 (60 Hz) ciklov za >95 % UT (sinhronizacijski kot (stopinj): 0)	Kakovost električnega omrežja mora biti enaka kot v tipičnem komercialnem ali bolnišničnem okolju. Če uporabnik pripomočka potrebuje neprekinjeno delovanje med prekinitvami električnega napajanja, je priporočljivo vzpostaviti napajanje prek brezprekinitvenega napajanja ali baterije.
Frekvenca moči (50Hz/60Hz) magnetna polja IEC 61000-4-8	30 A/m	30 A/m	Magnetna polja frekvence moči bi morale biti na ravni, ki je značilna za tipično mesto uporabe v tipičnem komercialnem ali bolnišničnem okolju.
OPOMBA: UT je izmenična napetost pred uporabo ravni za preizkušanje.			

Izjava o elektromagnetni združljivosti

Navodila in izjava proizvajalca – elektromagnetna odpornost			
Pripomoček je namenjen uporabi v spodaj navedenem elektromagnetnem okolju. Kupec ali uporabnik pripomočka mora zagotoviti uporabo v takem okolju.			
Preizkus odpornosti	Raven za preizkušanje IEC 60601	Raven skladnosti	Elektromagnetno okolje – navodila
Prevajana RF IEC 61000-4-6	3 Vrms 150 kHz do 80 MHz	Isto kot na levi	Prenosne in mobilne radiofrekvenčne komunikacijske opreme ni dovoljeno uporabljati bližje nobenemu delu pripomočka, vključno s kabli, kot znaša priporočena ločilna razdalja, izračunana na podlagi enačbe, ki se uporablja za frekvenco oddajnika. Priporočena ločilna razdalja $d = 1,2 \sqrt{P}$ $d = 1,2 \sqrt{P}$ 80 MHz do 800 MHz Pri čemer je P največja izhodna moč oddajnika, izražena v vatih (W) skladno s podatki proizvajalca oddajnika, d pa je priporočena ločilna razdalja v metrih (m).
Prevajanja RF IEC 61000-4-3	Profesionalno zdravstveno okolje 3 V/m Domače okolje 10 Vm 80 MHz do 2700 MHz	Isto kot na levi	Jakosti polj, ki jih oddajajo fiksni radiofrekvenčni oddajniki, določene z raziskavo elektromagnetnega sevanja, ^a morajo biti nižje od stopnje skladnosti v vsakem posamičnem frekvenčnem območju. ^b V bližini opreme, označene s spodnjim simbolom, se lahko pojavijo motnje. 
OPOMBA 1: Pri frekvencah 80 MHz in 800 MHz se uporablja višje frekvenčno območje.			
OPOMBA 2: Ta navodila morda ne veljajo v vseh primerih. Na širjenje elektromagnetnega sevanja vplivata absorpcija in odboj od struktur, predmetov in ljudi.			
a Jakosti polj iz fiksnih oddajnikov, kot so bazne postaje za brezžične telefone (tudi mobilne telefone) in prenosne radijske postaje, amaterske radijske postaje, radijskih valov AM in AF ter televizijskega signala v teoriji ni mogoče natančno določiti. Za oceno elektromagnetnega sevanja zaradi fiksnih radiofrekvenčnih oddajnikov je treba razmisliti o raziskavi elektromagnetnega sevanja na posamezni lokaciji. Če izmerjena jakost polja na lokaciji, kjer se uporablja pripomoček, presega veljavno zgoraj navedeno raven skladnosti s sevanjem RF, je treba pripomoček ves čas spremljati in preverjati njegovo delovanje.			
b V frekvenčnem območju od 150 kHz do 80 MHz mora biti jakost polja manjša od 3 V/m.			

Izjava o elektromagnetni združljivosti

Priporočena ločilna razdalja med prenosno in mobilno radiofrekvenčno komunikacijsko opremo ter pripomočkom.

Pripomoček je predviden za uporabo v elektromagnetnem okolju, v katerem so radiofrekvenčne motnje nadzorovane. Kupec ali uporabnik pripomočka lahko pripomore k preprečevanju elektromagnetnih motenj z ohranjanjem minimalne razdalje med prenosno in mobilno komunikacijsko radiofrekvenčno opremo (oddajniki) ter pripomočkom, kot je priporočeno spodaj, skladno z največjo izhodno močjo komunikacijske opreme.

Nazivna največja izhodna moč oddajnika (W)	Ločilna razdalja glede na frekvenco oddajnika (m)		
	150 KHz do 80 MHz $d = 1,2 \sqrt{P}$	80 MHz do 800 MHz $d = 1,2 \sqrt{P}$	800 MHz do 2.7GHz $d = 2,3 \sqrt{P}$
0,01	0,12	0,12	0,23
0,1	0,38	0,38	0,73
1	1,2	1,2	2,3
10	3,8	3,8	7,3
100	12	12	23

Za oddajnike z nazivno največjo izhodno močjo, ki ni navedena zgoraj, lahko priporočeno ločilno razdaljo d v metrih (m) določite na podlagi enačbe, ki se uporablja za frekvenco oddajnika, pri čemer je P največja nazivna izhodna moč oddajnika, izražena v vatih W (m) skladno s podatki proizvajalca oddajnika.

OPOMBA 1 Pri frekvencah 80 MHz in 800 MHz se uporablja ločilna razdalja za višje frekvenčno območje.

OPOMBA 2 Ta navodila morda ne veljajo v vseh primerih. Na širjenje elektromagnetnega sevanja vplivata absorpcija in odboj od struktur, predmetov in ljudi.

Garancija

Izdelek: Mediblink Ultrazvočni inhalator M480

Proizvajalec: Foshan City Shunde Toplife Electronic Technology Co., Ltd
7F, 6BLG, Zhifu Industrial Zone, Xingtan Town, Shunde District, Foshan City, Guangdong Province, 528325, P.R. China

Žig, podpis ter sedež prodajalca:

Datum izročitve:

GARANCIJSKI POGOJI

Spoštovane stranke!

Garancijska doba traja 3 leta in začne teči z dnem nakupa oziroma na dan predaje blaga ter velja le za izdelke, ki so bili kupljeni na območju Republike Slovenije. Pri uveljavljanju garancije je potrebno predložiti račun in izpolnjen garancijski list. Zato vas prosimo, da račun in garancijski list shranite!

Žal je napačna uporaba aparata razlog za približno 95 % reklamacij. S koristnimi nasveti našega posebej za vas urejenega servisnega centra, lahko te težave enostavno odpravite, zato nas pokličite na 07-30-44-555, ali pa se javite po e-pošti (servis@prolat.si).

Preden pošljete aparat na servis ali ga vrnete prodajalcu vam svetujemo, da se oglasite na naši dežurni telefonski številki, kjer vam bomo pomagali in vam tako prihranili nepotrebne poti.

Proizvajalec jamči brezplačno odpravo pomanjkljivosti, ki so posledica napak materiala ali proizvodnje, s pomočjo popravila ali menjave. V primeru, da popravilo ali zamenjava izdelka nista mogoča, proizvajalec kupcu vrne kupnino. Garancija ne velja za škodo, nastalo zaradi višje sile, nesreč, nepredvidenih dogodkov (na primer strele, vode, ognja itd.), nepravilne uporabe ali nepravilnega transporta, neupoštevanja varnostnih in vzdrževalnih predpisov ali zaradi nestrokovnega posega v izdelek.

Sledi vsakodnevne rabe izdelka (praske, odrgnine itd.) niso predmet garancije. Garancija ne izključuje pravic potrošnika, ki izhajajo iz odgovornosti prodajalca za napake na izdelku. Ob prevzemu izdelka, katerega je potrebno popraviti, servisno podjetje in prodajalec ne prevzemata odgovornosti za shranjene podatke oz. nastavitve. Popravila, ki se opravijo po izteku garancijske dobe, so ob predhodnem obvestilu plačljive.

Proizvajalec jamči za kakovost oziroma brezhibno delovanje izdelka v garancijskem roku, ki začne teči z izročitvijo blaga. Če popravila ni mogoče izvesti v 45 dnevem roku, bo izdelek zamenjan z novim. V kolikor menjava izdelka ni mogoča, bo kupcu povrnjena kupnina.

Garancijska doba na sestavne dele inhalatorja: posodica za zdravila oz. fiziološko raztopino, maski, povezovalna cev, ustnik in filtre je 1 leto.

V primeru reklamacije nas obvestite po e-pošti na servis@prolat.si ali po telefonu 07-30-44-555.

V primeru vsakega resnega zapleta, do katerega je prišlo v zvezi z medicinskim pripomočkom, mora uporabnik/pacient obvestiti proizvajalca medicinskega pripomočka in pristojni organ države članice, v kateri ima uporabnik in/ali pacient stalno prebivališče.

SLO

Zastopnik za SLO:
Prolat d.o.o.
Praproče 9
8210 Trebnje - SLO
Tel: +386-(0)7-30-44-555
info@prolat.si
Servis in reklamacije: servis@prolat.si
www.prolat.si

Proizvedeno za
(uvoznik v EU):
Mediblink d.o.o.
Gubčeva cesta 19
8210 Trebnje
Slovenija
info@mediblink.com
www.mediblink.com



Foshan City Shunde Toplife Electronic Technology Co., Ltd
7F, 6BLG, Zhifu Industrial Zone, Xingtan Town,
Shunde District, Foshan City,
Guangdong Province, 528325, P.R. China



Lotus NL B.V.
Koningin Julianaplein 10, 1e Verd, 2595AA,
The Hague, Netherlands
Tel: +31644168999 Email: peter@lotusnl.com

CE
1639

Verzija navodila za uporabo: A/8
Datum izdaje: 01.02.2020
Datum zadnjega popravka: 22.09.2021
Različica programske opreme: V1.0
Številka dokumenta: HSH-CE-01-016
SRN: CN-MF-000002235

Uvod

Poštovani korisniče,

Zahvaljujemo na odabiru Mediblink M480 ultrazvučnog inhalatora za aerosolnu terapiju koji je osmišljen i napravljen uz pomoć najnovije tehnologije.

Mediblink Ultrazvučni inhalator M480 spada u klasu IIa medicinskih uređaja koji pretvaraju lijek iz tekućine u aerosol i na taj način omogućavaju ulazak lijeka u dišne puteve.

Mediblink Ultrazvučni inhalator M480 stvara aerosolne čestice idealne veličine što omogućava dublju penetraciju lijeka u respiratorni trakt.

Mediblink Ultrazvučni raspršivač M480 omogućava, radi male veličine čestica, dublje prodiranje aerosola u gornje i donje dišne puteve.

Oprez!

Uređaj nije igračka i mora biti upotrebljavan samo u prisustvu odrasle osobe. Nikada ne ostavljajte djecu samu za vrijeme tretmana: uređaj sadrži sitne dijelove koji mogu biti progutani. Uređaj se treba spremiti nakon upotrebe na sigurno mjesto, izvan dosega djece. Kako bi se uređaj pravilno koristio prije upotrebe preporučljivo je pročitati listu upozorenja na sljedećoj stranici.

Pribor

Uređaj sadržava sljedeće dijelove koji se isporučuju u polietilenskoj omotnici dostavljenoj uz uređaj.

Popis pribora

Br.	Sastavni dio	Broj modela	Broj stavke	Materijal	Količina
1	Maska za odrasle	PNEMAD	180-S08MZ7	PVC+PP	1
2	Maska za djecu	PNEMIN	180-S09MZ8	PVC+PP	1
3	Čašica za lijek	PNEBCAM3	XC-S02YB	PVC	10
4	Brtveni prsten	PNEBUANL	180-G02DQ	Silikon	3
5	Produžetak	PNEBTUB3	180-S06SSG1	PP	1
6	Adapter	RSS1006-180240-W2B-H	180-D02SPQ	/	1
7	Usni nastavak	PNEMOU	180-S01YZ	PP	1
8	Nosni nastavak	PNEBNOS	180-S08BC7	PP	1

Slika 1: Pribor

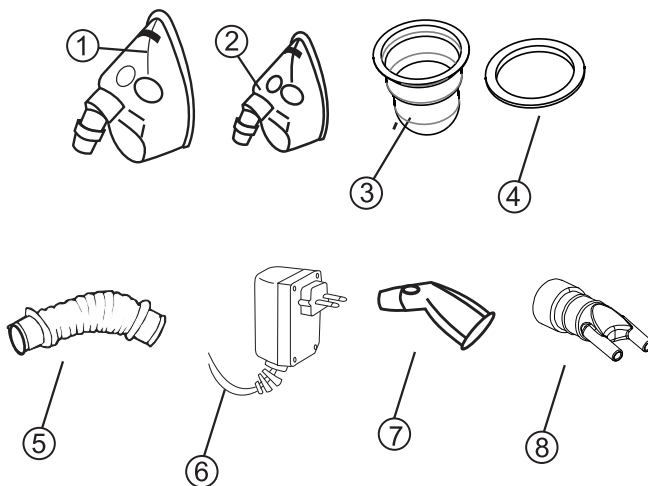

Dijelovi uređaja

Vaš ultrazvučni sustav Mediblink M480 za aerosolnu terapiju.

Slika 2: Dijelovi uređaja

- 1 – Mlaznica za atomizaciju
- 2 – Čašica za lijek
- 3 – Brtveni prsten
- 4 – Senzor razine vode
- 5 – Kućište uređaja sa spremnikom za vodu
- 6 – Prekidač
- 7 – Svjetlo upozorenja

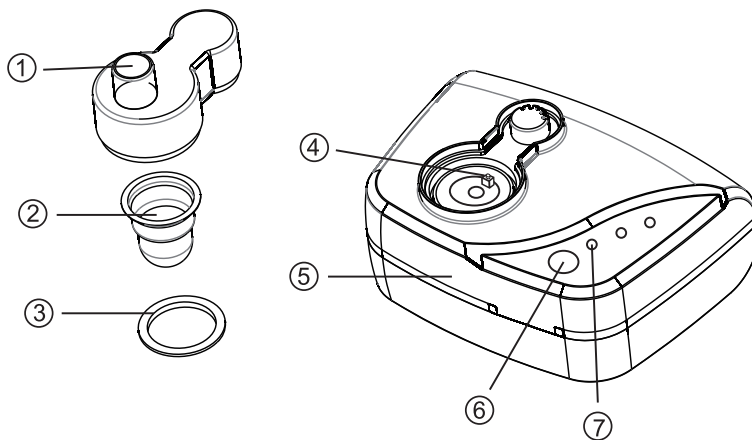

Uvod

Broj modela: ULTRANEB DESK 2

Pročitajte ovaj korisnički priručnik u cijelosti prije rukovanja ovim uređajem.

Namijenjena upotreba: Ultrazvučni inhalator za pacijente pri svijesti namijenjen je za pretvaranje tekućine salbutamol sulfata ili fiziološke otopine u aerosol za inhalaciju odraslih ili pacijenata na odjelu pedijatrije.

Kontraindikacije: Nikada nemojte upotrebljavati kod pacijenata u nesvijesti.

Ciljana skupina korisnika: Zakonski certificirani medicinski stručnjaci poput liječnika, tehničara i terapeuta ili zdravstvenog osoblja ili pacijenta uz smjernice kvalificiranih medicinskih stručnjaka za liječenje kod kuće.

Liječenje sljedećih zdravstvenih stanja: Uređaj je namijenjen za upotrebu u liječenju astme, KOPB-a i drugih respiratornih bolesti kod kojih je tijekom terapije potreban lijek u obliku aerosola.

Životni vijek uređaja je 5 godina.

Upozorenja i mjere opreza, oprez pri rukovanju

1. Držite oči podalje od izlaza maglice lijeka. Promijenite vodu nakon svake upotrebe.
2. Najveći kapacitet čašice za lijek je 10 ml i ne smije se prepuniti.
3. Razrijedite guste lijekove ili lijekove obujma od 2 ml ili manjeg u destiliranoj vodi ili fiziološkoj otopini kako biste dobili obujam od najmanje 4 ml.
4. Nemojte upotrebljavati ovaj uređaj dok upravljate vozilom.
5. Prestanite upotrebljavati uređaj odmah ako dođe do bilo kakve nelagode ili abnormalnosti.

Upozorenja

1. Nemojte izlagati inhalator visokim temperaturama, vlazi, prašini ili izravnoj svjetlosti.
2. Nemojte ga ispustiti iz ruku ili dopustiti izlaganje udarcima.
3. Kako biste izbjegli infekcije i zaraze, maska, čašica za lijek i produžetak moraju biti za jednokratnu upotrebu.
4. Nemojte napuniti spremnik iznad obujma navedenog u priručniku.
5. Nemojte ostavljati lijek u komori za raspršivanje ako se inhalator ne upotrebljava.
6. Isključite inhalator iz struje prije čišćenja i punjenja lijekom te nakon svake upotrebe.
7. Upotrebljavajte inhalator naizmjenično, tj. nakon 20 minuta prekinite uporabu na sljedećih 40 minuta te ga po potrebi ponovo upotrebljavajte najdulje 20 minuta.
8. Nikad nemojte prati, močiti ili uranjati inhalator u vodu ili bilo koju drugu tekućinu. Pratite precizne upute za njegovo čišćenje pod naslovom „ODRŽAVANJE I ČIŠĆENJE“ u ovom priručniku.
9. Nemojte ga upotrebljavati ako su vam ruke mokre jer postoji rizik od oštećenja raspršivača i ozljede korisnika.
10. Nikad nemojte upotrebljavati jedinicu ako su njezini dijelovi oštećeni (uključujući kabel za napajanje) ili ako je pao u vodu ili je uronjen u nju. Pošaljite ga bez odgađanja tehničkoj podršci na ispitivanja i popravak.
11. Djeca ne smiju upotrebljavati inhalator bez nadzora odraslih osoba.
12. Nemojte okretati inhalator zbog rizika od curenja lijeka i kvara.
13. Upotrebljavajte masku za odrasle, odnosno pedijatrijsku masku s potvrdom CE i brojem prijavljenog tijela.
14. Pribor je proizvod za jednokratnu upotrebu, ne smije se ponovo upotrebljavati. Ako ga želite zamijeniti novim priborom, obratite se lokalnom distributeru.
15. Svaki korisnik mora se koristiti vlastitim priborom i priborom koji je za jednokratnu upotrebu zbog higijenskih razloga.

Izlaz aerosola NaF

1. Ispitna metoda

- a) Upotrebljava se zrak.
- b) Raspršivač je napunjen lijekom za ispitivanje (2 ml NaF 1,0 % (M/V) uz protok od 2 l/min) za izlaznu brzinu aerosola i ispitivanje izlaska aerosola.
- c) Izlazak aerosola izražen je u mililitrima NaF 1,0 % (M/V).
- d) Raspršivač je napunjen lijekom za ispitivanje (2 ml NaF 2,5 % (M/V) uz protok od 2 l/min) za ispitivanje veličine čestica.

Izlaz aerosola NaF

2. Rezultati ispitivanja (najmanja brzina) NaF

Tablica 1: Sažetak rezultata ispitivanja predloženog uređaja (M480)

Test	Features	
Particle sizing	Total output particle mass (M_1 , μg)	26273.36 \pm 3410.11
	Particle mass collected by the cascade impactor (M_2 , μg)	354.63 \pm 15.38
	Particle mass collected by the outlet filter (M_3 , μg)	2228.35 \pm 108.35
	MMAD (μm)	1.52 \pm 0.1
	C.V. for the MMAD between four tests (%)	6.38
	Geometric Std. Dev. (GSD)	1.65 \pm 0.16
	C.V. for the GSD between four tests (%)	9.89
	Respirable fraction (% 0.5-5 μm)	93.49 \pm 0.9
	Respirable Mass (μg 0.5-5 μm)	331.61 \pm 17
	Treatment time (min)	1
	Course particle Fraction (%) (> 4.7 μm)	6.89 \pm 1.22
	Fine particle Fraction (%) (< 4.7 μm)	93.11 \pm 1.22
	Ultra-fine particle Fraction (%) (< 1 μm)	13.33 \pm 4.56
Aerosol output and aerosol output rate	Aerosol output (ml) ^a	2.06 \pm 0.13
	Aerosol output rate (ml/min) ^b	0.6 \pm 0.04

a : Continue the treatment until the medicine cup is empty or the mist stops.

b : The treatment time for aerosol output rate is 1 min.

Tablica 2: Maseni udio lijeka prikupljen u svakoj fazi ispitivanja udarnom glavom Marple

stage No.	Effective cutoff dia. (μm)	Cumulative fraction (%)					Mean collected mass per minute for each stage ($\mu\text{g}/\text{min}$)	Mean mass fraction for each stage (%)
		Test 1	Test 2	Test 3	Test 4	Mean		
1	21.3	100.00	100.00	100.00	100.00	100.00	9.40	2.65
2	14.8	97.30	97.27	97.41	97.41	97.35	9.55	2.69
3	9.8	94.13	94.87	94.93	94.66	94.65	10.90	3.07
4	6	91.07	91.64	92.00	91.58	91.57	33.85	9.55
5	3.5	79.45	83.50	83.05	81.98	82.00	85.10	24.00
6	1.6	52.85	60.81	59.54	58.59	57.95	186.20	52.51
7	0.93	11.92	0.00	6.73	3.99	5.66	19.28	5.44
8	0.53	0.30	0.00	0.11	0.00	0.10	0.35	0.10
after filter	<0.53	0.00	0.00	0.00	0.00	0.00	0.00	0.00
Total							354.63	

Slika A: Grafikon ukupne raspodjele veličina iz tablice 2.

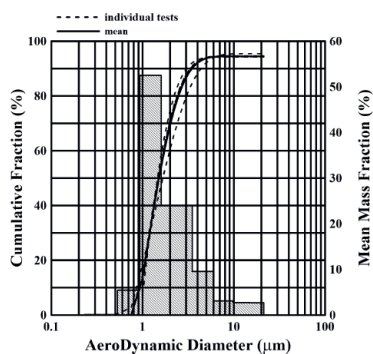

Reference

Rubow, K. L., Marple, V. A., Olin, J., and McCawley, M. A., 1987, "A Personal Cascade Impactor: Design, Evaluation and Calibration", *Am. Ind. Hyg. Assoc. J.* (48): 532-538.

Izlaz aerosola NaF

3. Rezultati ispitivanja (srednja brzina) NaF

Tablica 3: Sažetak rezultata ispitivanja predloženog uređaja (M480)

Test	Features	
Particle sizing	Total output particle mass (M_1 , μg)	32055.23 \pm 1531.12
	Particle mass collected by the cascade impactor (M_2 , μg)	304.15 \pm 10.46
	Particle mass collected by the outlet filter (M_3 , μg)	1436.3 \pm 515.7
	MMAD (μm)	1.39 \pm 0.06
	C.V. for the MMAD between four tests (%)	4.52
	Geometric Std. Dev. (GSD)	1.73 \pm 0.05
	C.V. for the GSD between four tests (%)	2.84
	Respirable fraction (% 0.5-5 μm)	95.92 \pm 1.04
	Respirable Mass (μg 0.5-5 μm)	291.67 \pm 7.54
	Treatment time (min)	1
	Coarse particle Fraction (%) ($>$ 4.7 μm)	4.48 \pm 1.14
	Fine particle Fraction (%) ($<$ 4.7 μm)	95.52 \pm 1.14
	Ultra-fine particle Fraction (%) ($<$ 1 μm)	26.06 \pm 2.12
Aerosol output and aerosol output rate	Aerosol output (ml) ^a	2.16 \pm 0.21
	Aerosol output rate (ml/min) ^b	0.67 \pm 0.07

a : Continue the treatment until the medicine cup is empty or the mist stops.

b : The treatment time for aerosol output rate is 1 min.

Tablica 4: Maseni udio lijeka prikupljen u svakoj fazi ispitivanja udarnom glavom Marple

stage No.	Effective cutoff dia. (μm)	Cumulative fraction (%)					Mean collected mass per minute for each stage ($\mu\text{g}/\text{min}$)	Mean mass fraction for each stage (%)
		Test 1	Test 2	Test 3	Test 4	Mean		
1	21.3	100.00	100.00	100.00	100.00	100.00	4.00	1.32
2	14.8	98.27	99.12	98.60	98.78	98.69	3.05	1.00
3	9.8	96.80	98.71	97.45	97.83	97.70	9.80	3.22
4	6	93.09	96.00	94.20	94.65	94.48	23.35	7.68
5	3.5	83.31	90.09	85.97	88.02	86.85	75.33	24.77
6	1.6	59.27	64.52	61.93	62.53	62.06	129.20	42.48
7	0.93	16.69	22.18	20.06	19.36	19.57	59.07	19.42
8	0.53	0.32	0.00	0.13	0.00	0.11	0.35	0.12
after filter	<0.53	0.00	0.00	0.00	0.00	0.00	0.00	0.00
Total							304.15	

Slika B: Grafikon ukupne raspodjele veličina iz tablice 4.

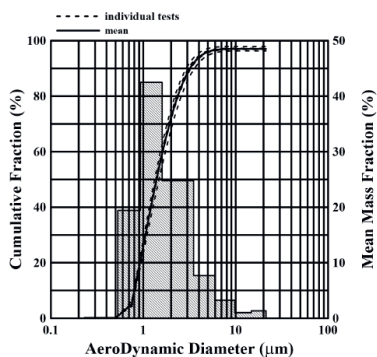

Reference

Rubow, K. L., Marple, V. A., Olin, J., and McCawley, M. A., 1987, "A Personal Cascade Impactor: Design, Evaluation and Calibration", *Am. Ind. Hyg. Assoc. J.* (48): 532-538.

Izlaz aerosola NaF

4. Rezultati ispitivanja (najveća brzina) NaF

Tablica 5: Sažetak rezultata ispitivanja predloženog uređaja (M480)

Test	Features	
Particle sizing	Total output particle mass (M_1 , μg)	23967.07 \pm 1633.28
	Particle mass collected by the cascade impactor (M_2 , μg)	256.75 \pm 136.63
	Particle mass collected by the outlet filter (M_3 , μg)	1488 \pm 426.33
	MMAD (μm)	1.19 \pm 0.18
	C.V. for the MMAD between four tests (%)	15.27
	Geometric Std. Dev. (GSD)	1.72 \pm 0.28
	C.V. for the GSD between four tests (%)	16.04
	Respirable fraction (% 0.5-5 μm)	96.43 \pm 2.09
	Respirable Mass (μg 0.5-5 μm)	245.52 \pm 128.01
	Treatment time (min)	1
	Coarse particle Fraction (%) (> 4.7 μm)	3.85 \pm 2.3
	Fine particle Fraction (%) (< 4.7 μm)	96.15 \pm 2.3
Ultra-fine particle Fraction (%) (< 1 μm)	41.04 \pm 13.1	
Aerosol output and aerosol output rate	Aerosol output (ml) ^a	2.15 \pm 0.04
	Aerosol output rate (ml/min) ^b	0.66 \pm 0.01

a : Continue the treatment until the medicine cup is empty or the mist stops.

b : The treatment time for aerosol output rate is 1 min.

Tablica 6: Maseni udio lijeka prikupljen u svakoj fazi ispitivanja udarnom glavom Marple

stage No.	Effective cutoff dia. (μm)	Cumulative fraction (%)					Mean collected mass per minute for each stage ($\mu\text{g}/\text{min}$)	Mean mass fraction for each stage (%)
		Test 1	Test 2	Test 3	Test 4	Mean		
1	21.3	100.00	100.00	100.00	100.00	100.00	5.05	1.97
2	14.8	100.00	97.66	98.32	97.80	98.45	3.25	1.27
3	9.8	100.00	96.14	97.17	96.45	97.44	5.90	2.30
4	6	100.00	93.40	95.31	93.83	95.63	18.00	7.01
5	3.5	97.25	85.89	88.04	86.55	89.43	51.45	20.04
6	1.6	94.50	63.91	68.73	64.12	72.82	94.30	36.73
7	0.93	50.50	28.83	30.12	28.48	34.48	78.25	30.48
8	0.53	1.50	0.00	0.09	0.24	0.46	0.55	0.21
after filter	-0.53	0.00	0.00	0.00	0.00	0.00	0.00	0.00
Total							256.75	

Slika C: Grafikon ukupne raspodjele veličina iz tablice 6.

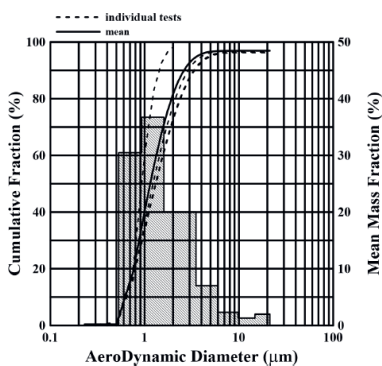

Reference

Rubow, K. L., Marple, V. A., Olin, J., and Mccawley, M. A., 1987, "A Personal Cascade Impactor: Design, Evaluation and Calibration", *Am. Ind. Hyg. Assoc. J.* (48): 532-538.

Upotreba simbola

Simboli	Značenje simbola
	Primijenjeni dio tipa BF
	Oprema II. klase
	Pogledajte priručnik/knjžicu s uputama http://www.mediblink.com/f/m480.pdf
	Proizvođač
	Datum proizvodnje
	Ovlašteni predstavnik u Europskoj zajednici
	Medicinski uređaj
	Šifra serije*
	Serijski broj
	Upotrijebiti do datuma
	Oznake električnih i elektroničkih uređaja u skladu su s Direktivom 2002/96/EZ. Uređaj, pribor i ambalažu na završetku upotrebe potrebno je pravilno odložiti u otpad. Pratite lokalne propise ili zakone koji se odnose na odlaganje.

Simboli	Značenje simbola
	Nije sterilno
	Ne upotrebljavati višekratno
	Oznaka CE
IP21	Zaštićeno od krutih stranih tijela veličine 12,5 mm i većih.
	Broj proizvoda u jednom pakiranju
	Ograničenje temperature skladištenja
	Ograničenje vlažnosti zraka skladištenja
	Ograničenje atmosferskog tlaka skladištenja
	Ovom stranom prema gore
	Lomljivo, pažljivo rukovati
	Ostaviti na suhom
	Ograničenje slaganja do 6 ambalaža
	Oprez!

*Datum proizvodnje: prvi par brojeva LOT-a predstavlja mjesec proizvodnje, drugi par predstavlja godinu proizvodnje. Primjer: LOT 1025 = listopad 2025.

Pratite precizne upute za upotrebu koje se nalaze u ovom priručniku i nemojte upotrebljavati inhalator na bilo koji drugi način koji nije opisan u ovom priručniku (poput upotrebe pribora koji nije isporučio proizvođač; umetanja predmeta ili otvaranja) zbog rizika od nezgoda i gubitka jamstva.



OPREZ – Upute za pravilno odlaganje proizvoda

Ovaj simbol znači da se proizvod nakon uporabe ne smije odlagati kao kućni otpad, nego se mora odložiti kao otpad u skladu s važećim propisima i zakonskim odredbama za izbjegavanje negativnih posljedica po zdravlje i okoliš.

Oprez pri skladištenju

Nemojte skladištiti uređaj na izravnoj sunčevoj svjetlosti, visokoj temperaturi ili vlažnosti zraka. Držite jedinicu dalje od dohvata male djece. Uređaj uvijek mora biti isključen iz struje dok nije u upotrebi.

Upute

1. Prije upotrebe ovog uređaja posavjetujte se sa svojim obiteljskim liječnikom.
2. Držite uređaj dalje od dohvata djece.
3. Kada je tretman dovršen, isključite uređaj iz struje izvlačenjem adaptera iz utičnice.

Za ispravnu upotrebu i vrijeme održavanja vašeg novog sustava aerosolne terapije preporučujemo pažljivo pročitati sljedeće upute.

Kako aktivirati vaš sustav M480 inhalator za terapiju aerosolom

Vodite računa da su uređaj i sav pribor temeljito čisti, potom nastavite sa sljedećim radnjama uzastopnim slijedom:

1. Postavite uređaj na stabilnu i голу ravnu površinu (stol bez stolnjaka ili drugog pokrivača) u blizini izvora napajanja.
2. Otvorite poklopac uređaja.
3. Uklonite gornji dio kako je prikazano na slici 1.
4. Napunite spremnik hladnom vodom iz slavine (ne smije se upotrebljavati čista ili filtrirana voda, pogledajte sliku 9.), upotrebljavajući mali spremnik kako je prikazano na slici 2., do razine naznačene u spremniku (slika 3.): ta voda omogućuje provođenje ultrazvučnih valova do lijeka i nikad se ne raspršuje.
5. Uzmite čašicu s lijekom i napunite je lijekom kako je prikazano na slici 4.
6. Postavite brtveni prsten na stroj oko ulaza spremnika prije nego što unutra postavite čašicu.
7. Postavite punu čašicu s lijekom u utor za nju ispod gornjeg dijela uređaja (slika 5.) bez prolijevanja lijeka iz čašice za lijek.
8. Zamijenite gornji dio na kućištu uređaja tako što ćete pažljivo spojiti dva dijela.
9. Spojite priključak na produžetak; zatim spojite slobodni kraj priključka na masku za emisiju raspršenog lijeka uređaja (slika 6.) i stavite na slobodni kraj produžetka bilo koju od dviju maski ili usni nastavak ili nastavak za nos ovisno o potrebnom tretmanu i odabranom načinu primjene lijeka.
10. Uključite postojeći adapter u utičnicu na pozadini uređaja.
11. ⚠Upozorenje! Strogo je zabranjeno ulijevati vodu u izlaz za zrak. Pogledajte sliku 8.
12. Označena razina vode u spremniku vode (vidi sliku 9.). Spremnik za vodu potrebno je upotrebljavati s vodom iz slavine, a čista voda ili filtrirana voda ne smiju se upotrebljavati jer senzor ne može raditi s njima

Uređaj je sada spreman za upotrebu.

Upute

Kako primijeniti aerosolnu terapiju

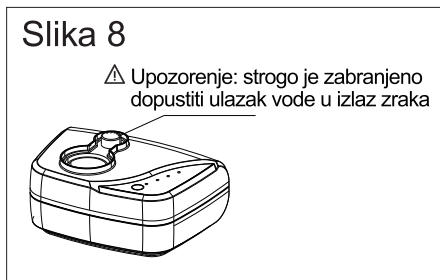
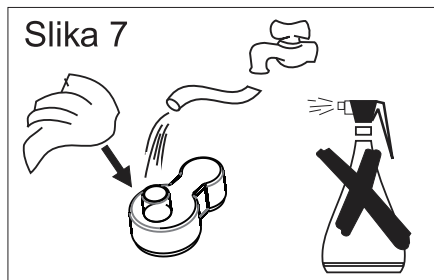
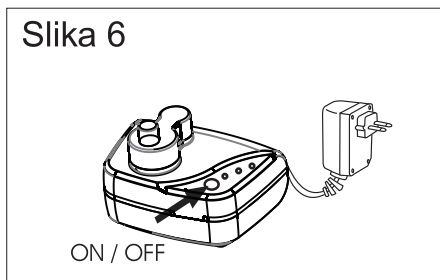
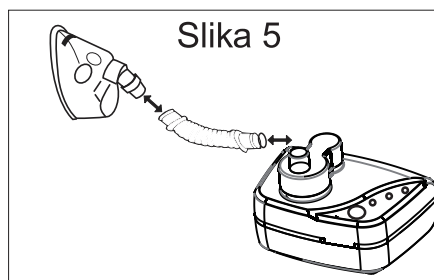
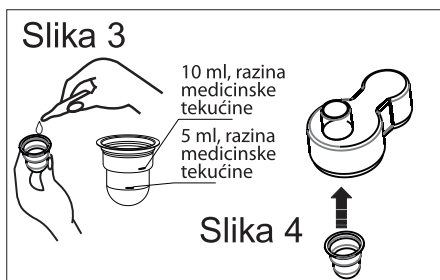
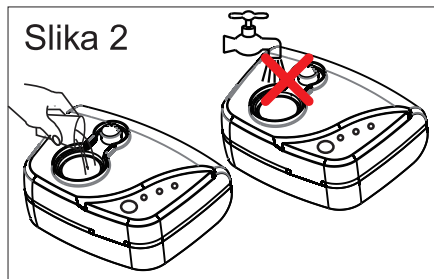
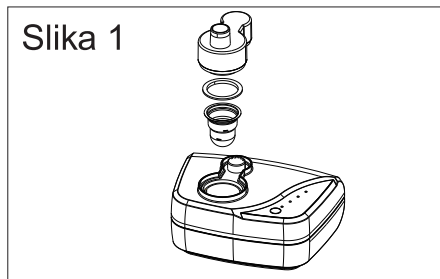

Upute

1. Uključite postojeći adapter u odgovarajuću utičnicu (pogledajte naljepnicu na dnu uređaja).
2. Pritisnite prekidač na vrhu uređaja: svjetlo upozorenja na vrhu svijetli (zeleno svjetlo), što znači da uređaj radi ispravno.
3. Započnite terapiju držeći uređaj u okomitom položaju tijekom cijelog tretmana kako biste omogućili ispravno funkcioniranje uređaja i postigli najveću učinkovitost.
4. Brzina raspršivanja uređaja može se kontrolirati pritiskom na „MIN“, „MID“ i „MAX“. Savjetujemo, ponajprije kod tretmana djece, okrenuti ručke u položaj „MIN“ kako biste pripomogli taloženju u dišnim putevima.
5. Nastavite s tretmanom dok ne vidite laganu maglicu (raspršivanje lijeka koje stvori uređaj).
6. Nakon jednokratnog tretmana potrebno je zamijeniti vodu u spremniku za sljedeći tretman.

⚠ Oprez: Obično na završetku tretmana mala količina lijeka ostaje u držaču lijeka: ta količina, koja se naziva zaostali volumen, ne može se raspršiti.

Kada je tretman gotov:

1. Isključite uređaj pritiskom na upravljački prekidač.
2. Isključite postojeći adapter iz izvora napajanja.
3. Uklonite postojeći adapter iz utičnice na pozadini uređaja.
4. Uklonite plavi priključak s kućišta i odspojite masku i drugi pribor s kraja cijevi.
5. Uklonite plavi priključak s cijevi.
6. Uklonite čašicu za lijek i brtveni prsten s kućišta uređaja.
7. Ispraznite vodu iz spremnika.
8. Pažljivo obrišite spremnik mekanom krpom i provjerite jesu li spremnik i plavi priključak potpuno suhi.
9. Vratite čašicu za lijek, prsten i plavi priključak na kućište uređaja.
10. Pospremite sav pribor u kutiju.

Čišćenje i održavanje

Oprez:

Provjerite čašicu za lijek i filter zraka prije svake upotrebe. Potrebno je zamijeniti prljave i istrošene dijelove. Nemojte uranjati jedinicu u vodu.

Važno je očistiti ultrazvučni inhalator prije nego što ga upotrijebite prvi put i nakon svake upotrebe. Zapamtite da je potrebno isključiti jedinicu iz električne utičnice. Nikad nemojte uranjati jedinicu u vodu. Može oštetiti jedinicu.

Nemojte upotrebljavati nikakva sredstva za čišćenje u prahu ili spužve natopljene deterdžentom koje mogu oštetiti površinu.

Čišćenje uređaja

1. Isključite jedinicu iz električne utičnice prije čišćenja.
2. Površinu glavne jedinice potrebno je očistiti mekanom krpom natopljenom neabrazivnim sredstvom za čišćenje i vodom temperature niže od 30°C. Nemojte izravno stavljati glavnu jedinicu u vodu. Ultrazvučni dio može se obrisati vatiranim štapićem s čistom vodom temperature niže od 30°C.
3. Operite mlaznicu za atomizaciju toplom vodom nakon svake upotrebe i očistite blagim deterdžentom nakon posljednjeg tretmana tog dana.
 ⚠ Oprez! Tijekom postupka čišćenja nemojte pritiskati na ultrazvučnu membranu jer se može trajno oštetiti.

Zamjena filtra

1. Nemojte upotrebljavati pamuk ili bilo koje druge materijale. Nemojte prati ili čistiti filter. Upotrebljavajte samo filtre koje vam je dostavio vaš distributer. Nemojte rukovati uređajem bez filtra.
2. Zamijenite filter svakih 30 dana ili kada filter posivi.
3. Postupak zamjene:
 - a) Uklonite poklopac filtra.
 - b) Zamijenite rabljeni filter novim.
 - c) Vratite poklopac filtra.

Kako očuvati učinkovitost vašeg uređaja

1. Vaš ultrazvučni sustav ULTRANEB DESK 2 za aerosolnu terapiju ne zahtijeva posebnu brigu za održavanje, samo je potrebno:
 - izbjegavati udarce ili ispuštanje s visine;
 - izbjegavati njegovo otvaranje u bilo kojim okolnostima;
 - držati ga na odgovarajućem mjestu, dalje od visokih temperatura, izravne sunčeve svjetlosti, vlage i prašine;
 - izbjegavati upotrebu uređaja dulje od 30 minuta bez prekida.
2. Pažljivo očistite sav upotrebljavan pribor nakon svake uporabe. Pribor možete oprati vodom iz slavine. Ako ga želite sterilizirati, možete upotrijebiti hladnu otopinu koju preporuča vaš obiteljski liječnik.
3. Preporučujemo najviše 2 tretmana uz upotrebu jednog medicinskog držača, zatim ga zamijenite.
4. Posebno preporučujemo zamjenu filtra za zrak nakon 15/20 tretmana ili kada posivi. Za zamjenu, postupite na sljedeći način:
 - uklonite poklopac s njegova utora ispod postolja uređaja;
 - zamijenite stari filter i umetnite novi;
 - vratite poklopac u njegov utor.

Tehnička svojstva

Naziv i broj modela	Mediblink Ultrazvučni inhalator M480, Model: ULTRANEB DESK 2
Napajanje	100–240 VAC 50/60 Hz, 0,6 A
Ultrazvučna frekvencija	2,4 MHz \pm 50 kHz
Stopa raspršivanja (NaF)	MIN: 0,4–0,64 ml/min MED: 0,6–0,8 ml/min MAX: 0,65–0,9 ml/min
Veličina čestica MMAD (NaF)	1,19-1,52 μ m
Obujam čašice za lijek	Najviše oko 10 ml
Razina buke	32,9 dB
Dimenzije	164 x 97 x 140 mm
Težina	Približno 425 g
Radna temperatura i vlažnost	10 °C do 40 °C (50 °F do 104 °F); od 10 do 85 % RV
Temperatura i vlažnost pri skladištenju i transportu	-20 °C do 70 °C (-4 °F do 158 °F); od 10 do 95 % RV

Slika 1: distribucija atomiziranih čestica (salbutamol sulfat)

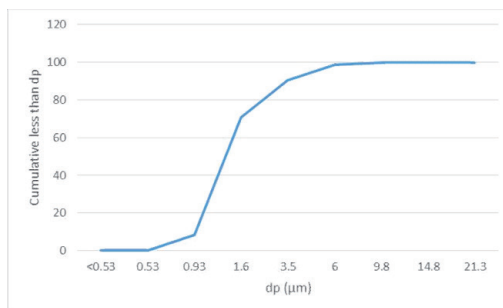

Prethodno navedena tehnička svojstva podložna su promjenama po vlastitu nahođenju proizvođača.

Rješavanje problema

Ako dođe do bilo kakvih abnormalnosti tijekom upotrebe, provjerite i ispravite sljedeće:

Stanje	Ispravak
Jednica ne radi kada se pritisne dugme ON/OFF.	Provjerite priključak adaptera izmjenične struje na utičnicu i/ili provjerite utikač izmjenične struje na ulazu izmjenične struje na uređaju. Provjerite je li spremnik za vodu napunjen do prave razine. Ako upotrebljavate s opcionalnim paketom baterija, provjerite je li baterija potpuno napunjena.
Nema stvaranja maglice ili niska stopa stvaranja maglice.	Provjerite ima li lijeka u čašici za lijek. Provjerite ima li oštećenja na čašici za lijek. Provjerite je li sonda čista.
Ventilator ne radi ispravno.	Uređaj trebate poslati u servis koji će provjeriti je li ventilator čvrsto i pravilno montiran na osovinu motora.

Izjava o elektromagnetskoj kompatibilnosti (EMC)

Smjernice i izjava proizvođača – elektromagnetsko zračenje		
Uređaj je namijenjen za upotrebu u elektromagnetskom okruženju navedenom u nastavku. Kupac ili korisnik uređaja mora voditi računa da se upotrebljava u takvu okruženju.		
Ispitivanje zračenja	Sukladnost	Elektromagnetsko okruženje – smjernice
RF emisije CISPR 11	1. skupina	Uređaj upotrebljava RF energiju samo za svoje interno funkcioniranje. Zato je njegovo RF zračenje vrlo nisko i nije vjerojatno da će uzrokovati bilo kakve smetnje za obližnju elektroničku opremu.
RF zračenje CISPR 11	Razred B	Uređaj je namijenjen za upotrebu u svim prostorima, osim kućanskih i onih izravno priključenih na javnu niskonaponsku distribucijsku mrežu koja napaja stambene zgrade.
Harmonijske emisije IEC 61000-3-2	Sukladan	
Kolebanja napona / emisije treperenja IEC 61000-3-3	Sukladan	

Izjava o elektromagnetskoj kompatibilnosti (EMC)

Smjernice i izjava proizvođača – elektromagnetska otpornost			
Uređaj je namijenjen za upotrebu u elektromagnetskom okruženju navedenom u nastavku. Kupac ili korisnik uređaja mora voditi računa da se upotrebljava u takvu okruženju.			
Ispitivanje otpornosti	Razina ispitivanja prema IEC 60601	Razina sukladnosti	Elektromagnetsko okruženje – smjernice
Elektrostatsko pražnjenje: IEC 61000-4-2	Kontakt: +8 KV Zrak: +2,+4,+8,+15 KV	Kontakt: +8 KV Zrak: +2,+4,+8,+15 KV	Podovi moraju biti drveni, betonski (ESD) ili keramički. Ako je pod prekriven sa sintetičkim materijalom, relativna vlažnost treba biti najmanje 30 %.
Električno brzi prijelazni/rafalni udar IEC 61000-4-4	Opskrbni ulazi za napajanje izmjeničnom strujom: AC: ± 2 KV Opskrbni ulazi za napajanje istosmjernom strujom: DC: ± 2 KV Signalni dovodni/odvodni ulazi: ± 1 KV	Opskrbni ulazi za napajanje izmjeničnom strujom: AC: ± 2 KV Opskrbni ulazi za napajanje istosmjernom strujom: DC: ± 2 KV Signalni dovodni/odvodni ulazi: ± 1 KV	Kvaliteta električne energije trebala bi biti tipična za komercijalno ili bolničko okruženje.
Prenapon IEC 61000-4-5	Opskrbni ulazi za napajanje: +0,5, +1,0 KV Signalni ulaz/izlaz: +2,0 kV	Signalni dovodni/odvodni ulazi: +0,5, +1,0 KV Opskrbni ulazi za napajanje: +2,0 kV	Kvaliteta električne energije trebala bi biti tipična za komercijalno ili bolničko okruženje.
Padovi napona, kratki prekidi i varijacije napona na ulaznim vodovima napajanja strujom IEC 61000-4-11	0,5 ciklusa za > 95 % (kut sinkronizacije (u stupnjevima)): 0, 45, 90, 135, 180, 225, 270, 315) 1 ciklus za > 95 % UT (kut sinkronizacije (u stupnjevima): 0) 25 (50 Hz)/ 30 (60 Hz) ciklusa za 30 % UT (kut sinkronizacije (u stupnjevima): 0) 250 (50 Hz)/ 300 (60 Hz) ciklusa za > 95 % UT (kut sinkronizacije (u stupnjevima): 0)	Opskrbni ulazi za napajanje: +0,5, +1,0 KV Signalni ulaz/izlaz: +2,0 kV 0,5 ciklusa za > 95 % (kut sinkronizacije (u stupnjevima)): 0, 45, 90, 135, 180, 225, 270, 315) 1 ciklus za > 95 % UT (kut sinkronizacije (u stupnjevima): 0) 25 (50 Hz)/ 30 (60 Hz) ciklusa za 30 % UT (kut sinkronizacije (u stupnjevima): 0) 250 (50 Hz)/ 300 (60 Hz) ciklusa za > 95 % UT (kut sinkronizacije (u stupnjevima): 0)	Kvaliteta električne energije trebala bi biti tipična za komercijalno ili bolničko okruženje. Ako je korisniku uređaja potreban neprekidan rad tijekom prekida napajanja, preporučuje se napajanje uređaja iz neprekinutog izvora napajanja ili pomoću baterije.
Frekvencija struje (50 Hz/60 Hz) magnetsko polje IEC 61000-4-8	30 A/m	30 A/m	Frekvencija struje magnetskih polja treba biti na karakterističnim razinama uobičajenih lokacija u uobičajenom trgovačkom ili bolničkom okruženju.
NAPOMENA: UT je napon glavnog napajanja izmjeničnom strujom prije primjene ispitne razine.			

Izjava o elektromagnetskoj kompatibilnosti (EMC)

Smjernice i izjava proizvođača – elektromagnetska otpornost			
Uređaj je namijenjen za upotrebu u elektromagnetskom okruženju navedenom u nastavku. Kupac ili korisnik uređaja mora voditi računa da se upotrebljava u takvu okruženju.			
Ispitivanje otpornosti	Razina ispitivanja prema IEC 60601	Sukladnost	Elektromagnetsko okruženje – smjernice
Inducirane RF IEC 61000-4-6	3 Vrms 150 kHz to 80 MHz	Jednako kao i preostala	<p>Prijenosna i mobilna RF komunikacijska oprema ne smije se upotrebljavati bliže od preporučene udaljenosti izračunane jednadžbom koja se primjenjuje za frekvenciju odašiljača od bilo kojeg dijela uređaja, uključujući kabele.</p> <p>Preporučena udaljenost</p> $d = 1,2 \sqrt{P}$ $d = 1,2 \sqrt{P} \text{ 80 MHz do 800 MHz}$ <p>Gdje je P najveća nazivna izlazna snaga odašiljača u vatima (W) prema proizvođaču odašiljača, a d je preporučena udaljenost u metrima (m).</p>
ozračeni RF IEC 61000-4-3	Profesionalno, zdravstvo okruženje: 3 V/m Kućno okruženje: 10 Vm 80 MHz do 2700 MHz	Jednako kao i preostala	<p>Jačine polja fiksnih RF odašiljača, kako je to određeno elektromagnetskim istraživanjem na lokaciji,^a trebale bi biti manje od razine sukladnosti u svakom rasponu frekvencija.^b Može doći do smetnji u blizini opreme Vm označene sljedećim simbolom: </p>
NAPOMENA 1: Pri 80 MHz i 800 MHz, primjenjuje se viši raspon frekvencije.			
NAPOMENA 2: Ove smjernice nisu primjenjive na sve slučajeve. Apsorpcija i odbijanje od zgrada, objekata i ljudi utječe na elektromagnetsku propagaciju.			
a Jačine polja fiksnih odašiljača, poput baznih radijskih postaja (mobilni/bežični telefoni i kopneni pokretni radiji, amaterski radiji, AM i FM radijski prijenos i televizijski prijenos ne mogu se s preciznošću predvidjeti u teoriji. Kako biste procijenili elektromagnetsko okruženje zbog fiksnih RF odašiljača, razmotrite mogućnost elektromagnetskog ispitivanja lokacije. Ako izmjerena snaga polja na lokaciji na kojoj se upotrebljava uređaj premašuje prethodno navedenu primjenjivu RF razinu sukladnosti, potrebno je promatrati uređaj kako bi se potvrdilo normalno funkcioniranje.			
b Pri frekvenciji koja premašuje raspon od 150 kHz do 80 MHz, jačine polja moraju biti manje od 3.			

Izjava o elektromagnetskoj kompatibilnosti (EMC)

Preporučena udaljenost između prijenosne i pokretne RF komunikacijske opreme i uređaja.			
Uređaj je namijenjen za upotrebu u elektromagnetskom okruženju u kojem se kontroliraju ozračene RF smetnje. Kupac ili korisnik uređaja može pomoći spriječiti elektromagnetske smetnje održavanjem minimalne udaljenosti između prijenosne i pokretne RF komunikacijske opreme (odašiljača) i uređaja, kako je preporučeno u nastavku, u skladu s najvećom izlaznom snagom komunikacijske opreme.			
Maksimalna nazivna izlazna snaga odašiljača (W)	Udaljenost prema frekvenciji odašiljača (m)		
	150 KHz do 80 MHz $d = 1,2 \sqrt{P}$	80 MHz do 800 MHz $d = 1,2 \sqrt{P}$	800 MHz do 2.7GHz $d = 2,3 \sqrt{P}$
0,01	0,12	0,12	0,23
0,1	0,38	0,38	0,73
1	1,2	1,2	2,3
10	3,8	3,8	7,3
100	12	12	23
<p>Za odašiljače čija maksimalna nazivna izlazna snaga nije prethodno navedena preporučena udaljenost d u metrima (m) može se procijeniti pomoću jednadžbe koja se primjenjuje za frekvenciju odašiljača, gdje je P najveća nazivna izlazna snaga odašiljača u vatima (W) prema proizvođaču odašiljača.</p> <p>NAPOMENA 1: Pri 80 MHz i 800 MHz primjenjuje se udaljenost za viši raspon frekvencije.</p> <p>NAPOMENA 2: Ove smjernice nisu primjenjive na sve slučajeve. Apsorpcija i odbijanje od zgrada, objekata i ljudi utječe na elektromagnetsku propagaciju.</p>			

Jamstvo

Proizvod: Mediblink Ultrazvučni inhalator M480

Proizvođač: Foshan City Shunde Toplife Electronic Technology Co., Ltd
7F, 6BLG, Zhifu Industrial Zone, Xingtan Town, Shunde District, Foshan City, Guangdong Province, 528325, P.R. China

Ime, adresa, potpis i pečat prodavatelja:

Datum preuzimanja/prodaje:

UVJETI JAMSTVA

Poštovani kupci!

Jamstveni rok je 3 godine, a počinje danom kupnje ili danom isporuke robe i vrijedi samo za proizvode kupljene na području Republike Hrvatske. Pri korištenju jamstva potrebno je dostaviti račun i jamstvenu karticu. Stoga vas molimo da spremite račun i jamstvenu karticu!

Nažalost, zlorporaba uređaja je uzrok oko 95% pritužbi. Pomoću korisnih savjeta našeg servisnog centra lako možete riješiti te probleme, stoga nas nazovite ili nam se obratite putem e-maila (info@golia.hr).

Prije slanja uređaja u servis ili vraćanja prodavatelju, savjetujemo vam da nas kontaktirate telefonom.

Proizvođač jamči popravkom ili zamjenom sve greške u radu uređaja nastale uslijed nedostatka materijala ili proizvodnje. U slučaju da popravak ili zamjena proizvoda nije moguća, proizvođač vraća kupovnu cijenu kupcu.

Jamstvo se ne odnosi na: štete uzrokovane višom silom, nesreće, nepredviđene događaje (poput munje, poplave, požara itd.), nepravilnu upotrebu ili neispravni prijevoz, nepoštivanje propisa o sigurnosti ili održavanju ili neprofesionalnu intervenciju prilikom kvara proizvoda.

Tragovi svakodnevne uporabe (ogrebotine, udarci itd.) ne podliježu jamstvu. Jamstvo isključuje prava potrošača na naknadu štete koja proizlazi iz neodgovornosti prodavatelja. Kada preuzmu proizvod koji treba popraviti, servisna tvrtka i prodavatelj ne preuzimaju odgovornost za pohranjene podatke i postavke. Popravci izvršeni nakon isteka jamstvenog roka podložni su prethodnoj obavijesti.

Proizvođač jamči kvalitetu i besprijekoran rad proizvoda u jamstvenom roku koji počinje s datumom isporuke robe. Ako se popravak ne može izvršiti u razdoblju od 45 dana, proizvod će se zamijeniti ili će se, na pristanak kupca, izvršiti povrat novca.

Jamstveni rok na pribor (posudicu za lijek/fiziološku otopinu, maske, crijevo, nastavak za usta i filtere) je 1 godina.

U slučaju pritužbe, kontaktirajte nas telefonom na broj 01/6198 496 ili pošaljite e-mail na info@golia.hr.

U slučaju ozbiljne komplikacije ili štetnog događaja koji se dogodio upotrebom medicinskog proizvoda, korisnik/pacijent mora obavijestiti proizvođača i nadležno tijelo države članice u kojoj ima prebivalište.

HRV

Zastupnik za HR:
Golia d.o.o.
XI Vrbik 3
10000 Zagreb
Tel: (01) 61-98-496
info@golia.hr
Servis i reklamacije: info@golia.hr
www.golia.hr

Proizvedeno za
(EU importer/uvoznik):
Mediblink d.o.o.
Gubčeva cesta 19
8210 Trebnje
Slovenija
info@mediblink.com
www.mediblink.com



Foshan City Shunde Toplife Electronic Technology Co., Ltd
7F, 6BLG, Zhifu Industrial Zone, Xingtang Town,
Shunde District, Foshan City,
Guangdong Province, 528325, P.R. China



Lotus NL B.V.
Koningin Julianaplein 10, 1e Verd, 2595AA,
The Hague, Netherlands
Tel: +31644168999 Email: peter@lotusnl.com

CE
1639

Verzija uputa za uporabu: A/8
Datum izdavanja: 01.02.2020
Datum zadnjeg popravka: 22.09.2021
Inačica softvera: V1.0
Broj dokumenta: HSH-CE-01-016
SRN: CN-MF-000002235